

vijaki, vložki pritržilna tehnika



STARMAN

So ljudje, ki dajo lesu še lepšo obliko in podobo
in smo ljudje, ki jim pri tem pomagamo in svetujemo.

STARMAN



Kazalo



1-18 Univerzalni vijaki Spax



19-22 Vijaki za lesno gradnjo Spax



23, 24 Vijaki za lesene terase Spax-D



25, 26 Vijaki za lesene fasade Spax



27, 28 Vijaki za tla iz masivnega lesa Spax-M



29, 30 Vijaki za MDF Spax-M



31, 32 Vijaki za hrbtišče Spax



33, 34 Vijaki za okenske okvirje Spax FEX-A



35, 36 Vijaki za okovje Spax FEX-KS



37-39 Zidni vijaki Spax-RA



40-57 Zidni vložki in pribor Mungo



58-67 Zidni vložki in pribor Apolo MEA



68-86 Vijaki, matice, podložke, ...



87-94 Kotniki



95 Letve



96-98 Vezne ploščice



99-105 Selotejpi, lepilni trakovi
pribor za spenjanje



106-108 Mozniki, lamelice, smolike, grče



109, 110 Podstavki za cevi



111 Samolepilne pokrivne kapice



Višja fleksibilnost
zaradi univerzalne uporabnosti

Tako neverjeten
kot je videti

Prednosti

- univerzalno uporaben
- ne razceplja materiala
- brez predhodnega vrtanja
- hiter in enostaven za uporabo



Štirikotna konica 4 CUT skupaj z MULTI glavo in izpopolnjenim valovitim profilom tvori vijak visoko razvite tehnologije v absolutno najvišjem razredu.

- prime takoj
- univerzalno uporaben
- ne razceplja materiala
- brez predhodnega vrtanja
- hiter in enostaven za uporabo



Štirikotna konica 4 CUT

- ne razceplja materiala
- brez predhodnega vrtanja
- štirikotna oblika loči vlakna



MULTI glava

- rezka v les
- zavira na kovini
- tesno prilegajoč ugrez



Izpopolnjen valovit profil

- do konice
- hitro in varno privitje



T-STAR plus

- čisti sedež nastavka
- boljše vodenje vijaka



Univerzalni vijak - ugrezna glava križna zareza PZ, cel navoj

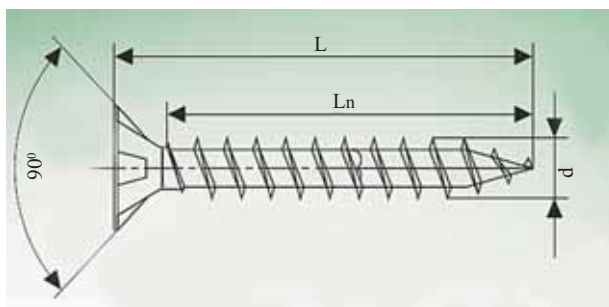

Šifra	Naziv	d (ø) mm	L mm	Ln mm
002511	Vijak Spax vgr. gl. 2,5x10 cel navoj bel	2,5	10	8
002513	Vijak Spax vgr. gl. 2,5x12 cel navoj bel	2,5	12	10
002515	Vijak Spax vgr. gl. 2,5x16 cel navoj bel	2,5	16	14
002519	Vijak Spax vgr. gl. 2,5x20 cel navoj bel	2,5	20	17
002526	Vijak Spax vgr. gl. 2,5x25 cel navoj bel	2,5	25	22
003009	Vijak Spax vgr. gl. 3,0x10 cel navoj bel	3,0	10	7
003011	Vijak Spax vgr. gl. 3,0x12 cel navoj bel	3,0	12	10
003014	Vijak Spax vgr. gl. 3,0x13 cel navoj bel	3,0	13	10
003503	Vijak Spax vgr. gl. 3,0x15 cel navoj bel	3,0	15	12
003018	Vijak Spax vgr. gl. 3,0x16 cel navoj bel	3,0	16	14
003019	Vijak Spax vgr. gl. 3,0x17 cel navoj bel	3,0	17	14
003021	Vijak Spax vgr. gl. 3,0x20 cel navoj bel	3,0	20	17
003026	Vijak Spax vgr. gl. 3,0x25 cel navoj bel	3,0	25	22
003029	Vijak Spax vgr. gl. 3,0x30 cel navoj bel	3,0	30	26
003034	Vijak Spax vgr. gl. 3,0x35 cel navoj bel	3,0	35	31
003041	Vijak Spax vgr. gl. 3,0x40 cel navoj bel	3,0	40	36
003044	Vijak Spax vgr. gl. 3,0x45 cel navoj bel	3,0	45	36
003509	Vijak Spax vgr. gl. 3,5x10 cel navoj bel	3,5	10	7
003511	Vijak Spax vgr. gl. 3,5x12 cel navoj bel	3,5	12	9
003514	Vijak Spax vgr. gl. 3,5x13 cel navoj bel	3,5	13	9
003515	Vijak Spax vgr. gl. 3,5x15 cel navoj bel	3,5	15	11
003516	Vijak Spax vgr. gl. 3,5x16 cel navoj bel	3,5	16	13
003522	Vijak Spax vgr. gl. 3,5x17 cel nav. bel stari	3,5	17	13
003521	Vijak Spax vgr. gl. 3,5x20 cel navoj bel	3,5	20	16
003526	Vijak Spax vgr. gl. 3,5x25 cel navoj bel	3,5	25	21
003531	Vijak Spax vgr. gl. 3,5x30 cel navoj bel	3,5	30	25
003538	Vijak Spax vgr. gl. 3,5x35 cel navoj bel	3,5	35	30
003543	Vijak Spax vgr. gl. 3,5x40 cel navoj bel	3,5	40	35
003547	Vijak Spax vgr. gl. 3,5x45 cel navoj bel	3,5	45	40
003552	Vijak Spax vgr. gl. 3,5x50 cel navoj bel	3,5	50	40

Univerzalni vijak z ugrezno glavo

- tako neverjeten, kot je videti
- univerzalna uporaba
- ugrezna glava
- belo cinkan
- ojačan, sintran s plastiko
- čisto uvijanje
- ne razceplja materiala tudi pri majhnih razdaljah od robov
- brez predhodnega vrtanja
- več moči z manjšo silo
- hiter in enostaven za uporabo
- zareza v glavi:
 - vijak ø 2,5 mm, ø 3,0 mm: križna zareza PZ1
 - vijak ø 3,5 mm: križna zareza PZ2



Univerzalni vijak - ugrezna glava križna zarez PZ, cel navoj

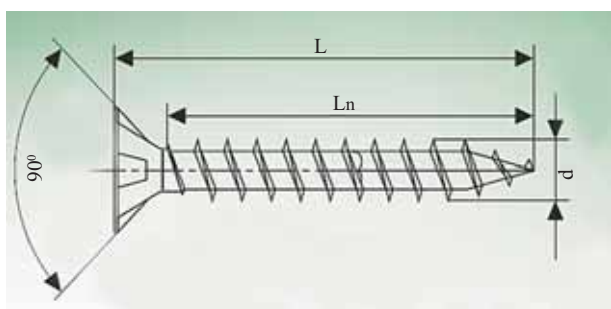

Šifra	Naziv	d (ø) mm	L mm	Ln mm
004012	Vijak Spax vgr. gl. 4,0x12 cel navoj bel	4,0	12	9
004014	Vijak Spax vgr. gl. 4,0x15 cel navoj bel	4,0	15	11
004018	Vijak Spax vgr. gl. 4,0x16 cel navoj bel	4,0	16	13
004019	Vijak Spax vgr. gl. 4,0x17 cel navoj bel	4,0	17	13
004021	Vijak Spax vgr. gl. 4,0x20 cel navoj bel	4,0	20	16
004026	Vijak Spax vgr. gl. 4,0x25 cel navoj bel	4,0	25	21
004031	Vijak Spax vgr. gl. 4,0x30 cel navoj bel	4,0	30	25
004038	Vijak Spax vgr. gl. 4,0x35 cel navoj bel	4,0	35	30
004043	Vijak Spax vgr. gl. 4,0x40 cel navoj bel	4,0	40	35
004048	Vijak Spax vgr. gl. 4,0x45 cel navoj bel	4,0	45	40
004053	Vijak Spax vgr. gl. 4,0x50 cel navoj bel	4,0	50	45
004058	Vijak Spax vgr. gl. 4,0x55 cel navoj bel	4,0	55	50
004061	Vijak Spax vgr. gl. 4,0x60 cel navoj bel	4,0	60	50
004080	Vijak Spax vgr. gl. 4,0x80 cel navoj bel	4,0	80	50
004517	Vijak Spax vgr. gl. 4,5x16 cel navoj bel	4,5	16	13
004521	Vijak Spax vgr. gl. 4,5x20 cel navoj bel	4,5	20	15
004526	Vijak Spax vgr. gl. 4,5x25 cel navoj bel	4,5	25	20
004531	Vijak Spax vgr. gl. 4,5x30 cel navoj bel	4,5	30	25
004536	Vijak Spax vgr. gl. 4,5x35 cel navoj bel	4,5	35	30
004543	Vijak Spax vgr. gl. 4,5x40 cel navoj bel	4,5	40	34
004548	Vijak Spax vgr. gl. 4,5x45 cel navoj bel	4,5	45	39
004553	Vijak Spax vgr. gl. 4,5x50 cel navoj bel	4,5	50	44
004558	Vijak Spax vgr. gl. 4,5x55 cel navoj bel	4,5	55	49
004562	Vijak Spax vgr. gl. 4,5x60 cel navoj bel	4,5	60	54
004581	Vijak Spax vgr. gl. 4,5x80 cel navoj bel	4,5	80	59

Univerzalni vijak z ugrezno glavo

- tako neverjeten, kot je videti
- univerzalna uporaba
- ugrezna glava
- belo cinkan
- ojačan, sintran s plastiko
- čisto uvijanje
- ne razceplja materiala tudi pri majhnih razdaljah od robov
- brez predhodnega vrtanja
- več moči z manjšo silo
- hiter in enostaven za uporabo
- zarez v glavi: križna zarez PZ2



Univerzalni vijak - ugrezna glava križna zareza PZ, cel navoj

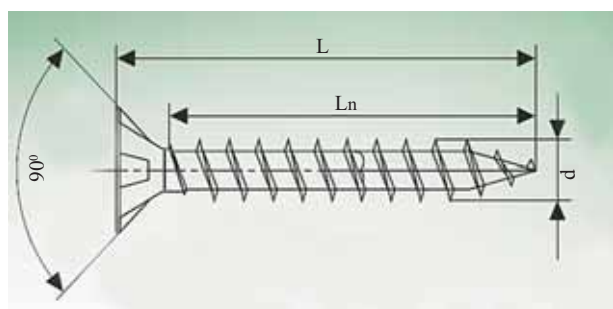

Šifra	Naziv	d (ø) mm	L mm	Ln mm
005017	Vijak Spax vgr. gl. 5,0x16 cel navoj bel	5,0	16	12
005021	Vijak Spax vgr. gl. 5,0x20 cel navoj bel	5,0	20	15
005026	Vijak Spax vgr. gl. 5,0x25 cel navoj bel	5,0	25	20
005031	Vijak Spax vgr. gl. 5,0x30 cel navoj bel	5,0	30	25
005036	Vijak Spax vgr. gl. 5,0x35 cel navoj bel	5,0	35	30
005043	Vijak Spax vgr. gl. 5,0x40 cel navoj bel	5,0	40	35
005048	Vijak Spax vgr. gl. 5,0x45 cel navoj bel	5,0	45	39
005052	Vijak Spax vgr. gl. 5,0x50 cel navoj bel	5,0	50	44
005063	Vijak Spax vgr. gl. 5,0x60 cel navoj bel	5,0	60	54
005073	Vijak Spax vgr. gl. 5,0x70 cel navoj bel	5,0	70	61
005083	Vijak Spax vgr. gl. 5,0x80 cel navoj bel	5,0	80	61
006031	Vijak Spax vgr. gl. 6,0x30 cel navoj bel	6,0	30	24
006041	Vijak Spax vgr. gl. 6,0x40 cel navoj bel	6,0	40	34
006046	Vijak Spax vgr. gl. 6,0x45 cel navoj bel	6,0	45	38
006052	Vijak Spax vgr. gl. 6,0x50 cel navoj bel	6,0	50	43
006056	Vijak Spax vgr. gl. 6,0x55 cel navoj bel	6,0	55	48
006063	Vijak Spax vgr. gl. 6,0x60 cel navoj bel	6,0	60	53
006073	Vijak Spax vgr. gl. 6,0x70 cel navoj bel	6,0	70	61
006083	Vijak Spax vgr. gl. 6,0x80 cel navoj bel	6,0	80	61

Univerzalni vijak z ugrezno glavo

- tako neverjeten, kot je videti
- univerzalna uporaba
- ugrezna glava
- belo cinkan
- ojačan, sintran s plastiko
- čisto uvijanje
- ne razceplja materiala tudi pri majhnih razdaljah od robov
- brez predhodnega vrtanja
- več moči z manjšo silo
- hiter in enostaven za uporabo
- zareza v glavi:
 - vijak ø 5,0 mm: križna zareza PZ2
 - vijak ø 6,0 mm: križna zareza PZ3



Univerzalni vijak - ugrezna glava križna zareza PZ, cel navoj

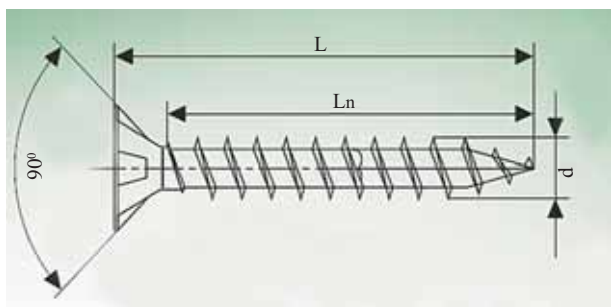

Šifra	Naziv	d (ø) mm	L mm	Ln mm
003022	Vijak Spax vgr. gl. 3,0x20 CN B industrija	3,0	20	17
003518	Vijak Spax vgr. gl. 3,5x15 CN B industrija	3,5	15	11
003519	Vijak Spax vgr. gl. 3,5x17 CN B industrija	3,5	17	13
004022	Vijak Spax vgr. gl. 4,0x20 CN B industrija	4,0	20	16
004039	Vijak Spax vgr. gl. 4,0x30 CN B industrija	4,0	30	25
004044	Vijak Spax vgr. gl. 4,0x40 CN B industrija	4,0	40	35
004054	Vijak Spax vgr. gl. 4,0x50 CN B industrija	4,0	50	45
005054	Vijak Spax vgr. gl. 5,0x50 CN B industrija	5,0	50	44
005064	Vijak Spax vgr. gl. 5,0x60 CN B industrija	5,0	60	54

Univerzalni vijak z ugrezno glavo

- tako neverjeten, kot je videti
- univerzalna uporaba
- ugrezna glava
- belo cinkan
- ojačan, sintran s plastiko
- čisto uvijanje
- ne razceplja materiala tudi pri majhnih razdaljah od robov
- brez predhodnega vrtanja
- več moči z manjšo silo
- hiter in enostaven za uporabo
- zareza v glavi:
 - vijak ø 3,0 mm: križna zareza PZ1
 - vijak ø 3,5 mm, ø 4,0 mm, ø 5,0 mm: križna zareza PZ2



Univerzalni vijak - ugrezna glava križna zarez PZ, delni navoj

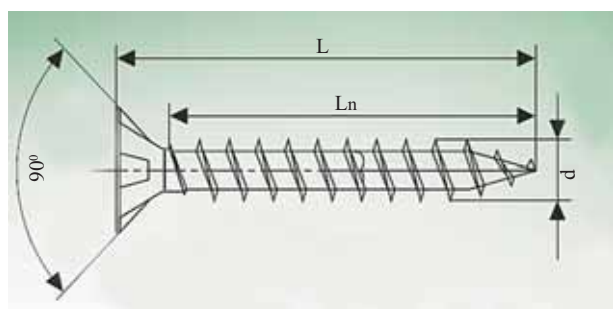

Šifra	Naziv	d (ø) mm	L mm	Ln mm
003533	Vijak Spax vgr. gl. 3,5x30 delni navoj bel	3,5	30	18
003536	Vijak Spax vgr. gl. 3,5x35 delni navoj bel	3,5	35	23
003541	Vijak Spax vgr. gl. 3,5x40 delni navoj bel	3,5	40	23
003548	Vijak Spax vgr. gl. 3,5x45 delni navoj bel	3,5	45	30
003553	Vijak Spax vgr. gl. 3,5x50 delni navoj bel	3,5	50	32
004034	Vijak Spax vgr. gl. 4,0x30 delni navoj bel	4,0	30	18
004036	Vijak Spax vgr. gl. 4,0x35 delni navoj bel	4,0	35	23
004041	Vijak Spax vgr. gl. 4,0x40 delni navoj bel	4,0	40	23
004046	Vijak Spax vgr. gl. 4,0x45 delni navoj bel	4,0	45	30
004051	Vijak Spax vgr. gl. 4,0x50 delni navoj bel	4,0	50	32
004057	Vijak Spax vgr. gl. 4,0x55 delni navoj bel	4,0	55	32
004062	Vijak Spax vgr. gl. 4,0x60 delni navoj bel	4,0	60	35
004070	Vijak Spax vgr. gl. 4,0x70 delni navoj bel	4,0	70	50
004081	Vijak Spax vgr. gl. 4,0x80 delni navoj bel	4,0	80	50
004532	Vijak Spax vgr. gl. 4,5x30 delni navoj bel	4,5	30	17
004537	Vijak Spax vgr. gl. 4,5x35 delni navoj bel	4,5	35	25
004542	Vijak Spax vgr. gl. 4,5x40 delni navoj bel	4,5	40	25
004547	Vijak Spax vgr. gl. 4,5x45 delni navoj bel	4,5	45	30
004552	Vijak Spax vgr. gl. 4,5x50 delni navoj bel	4,5	50	32
004557	Vijak Spax vgr. gl. 4,5x55 delni navoj bel	4,5	55	37
004563	Vijak Spax vgr. gl. 4,5x60 delni navoj bel	4,5	60	37
004571	Vijak Spax vgr. gl. 4,5x70 delni navoj bel	4,5	70	42
004580	Vijak Spax vgr. gl. 4,5x80 delni navoj bel	4,5	80	59

Univerzalni vijak z ugrezno glavo

- tako neverjeten, kot je videti
- univerzalna uporaba
- ugrezna glava
- belo cinkan
- ojačan, sintran s plastiko
- čisto uvijanje
- ne razceplja materiala tudi pri majhnih razdaljah od robov
- brez predhodnega vrtanja
- več moči z manjšo silo
- hiter in enostaven za uporabo
- zarez v glavi: križna zarez PZ2



Univerzalni vijak - ugrezna glava križna zarez PZ, delni navoj

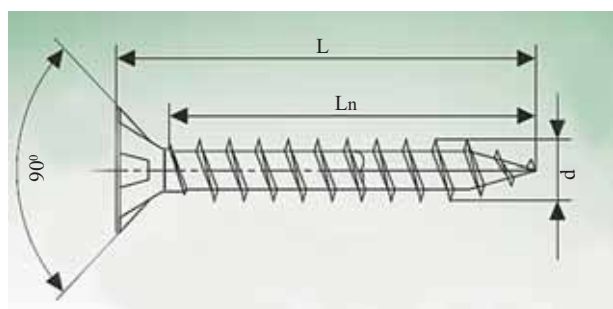

Šifra	Naziv	d (ø) mm	L mm	Ln mm
005041	Vijak Spax vgr. gl. 5,0x40 delni navoj bel	5,0	40	27
005046	Vijak Spax vgr. gl. 5,0x45 delni navoj bel	5,0	45	30
005053	Vijak Spax vgr. gl. 5,0x50 delni navoj bel	5,0	50	32
005056	Vijak Spax vgr. gl. 5,0x55 delni navoj bel	5,0	55	37
005061	Vijak Spax vgr. gl. 5,0x60 delni navoj bel	5,0	60	37
005071	Vijak Spax vgr. gl. 5,0x70 delni navoj bel	5,0	70	41
005081	Vijak Spax vgr. gl. 5,0x80 delni navoj bel	5,0	80	46
005091	Vijak Spax vgr. gl. 5,0x90 delni navoj bel	5,0	90	61
005101	Vijak Spax vgr. gl. 5,0x100 delni navoj bel	5,0	100	61
005121	Vijak Spax vgr. gl. 5,0x120 delni navoj bel	5,0	120	69
006053	Vijak Spax vgr. gl. 6,0x50 delni navoj bel	6,0	50	32
006061	Vijak Spax vgr. gl. 6,0x60 delni navoj bel	6,0	60	37
006071	Vijak Spax vgr. gl. 6,0x70 delni navoj bel	6,0	70	41
006081	Vijak Spax vgr. gl. 6,0x80 delni navoj bel	6,0	80	46
006091	Vijak Spax vgr. gl. 6,0x90 delni navoj bel	6,0	90	61
006101	Vijak Spax vgr. gl. 6,0x100 delni navoj bel	6,0	100	61
006111	Vijak Spax vgr. gl. 6,0x110 delni navoj bel	6,0	110	68
006121	Vijak Spax vgr. gl. 6,0x120 delni navoj bel	6,0	120	68
006131	Vijak Spax vgr. gl. 6,0x130 delni navoj bel	6,0	130	68
006141	Vijak Spax vgr. gl. 6,0x140 delni navoj bel	6,0	140	68
006151	Vijak Spax vgr. gl. 6,0x150 delni navoj bel	6,0	150	68
S štirikotnim rezkarjem 4 CUT				
006161	Vijak Spax vgr. gl. 6,0x160 delni navoj bel	6,0	160	65
006181	Vijak Spax vgr. gl. 6,0x180 delni navoj bel	6,0	180	65
006201	Vijak Spax vgr. gl. 6,0x200 delni navoj bel	6,0	200	65
006220	Vijak Spax vgr. gl. 6,0x220 delni navoj bel	6,0	220	65
006241	Vijak Spax vgr. gl. 6,0x240 delni navoj bel	6,0	240	65

Univerzalni vijak z ugrezno glavo

- tako neverjeten, kot je videti
- univerzalna uporaba
- ugrezna glava
- belo cinkan
- ojačan, sintran s plastiko
- čisto uvijanje
- ne razceplja materiala tudi pri majhnih razdaljah od robov
- brez predhodnega vrtanja
- več moči z manjšo silo
- hiter in enostaven za uporabo
- zarez v glavi:
 - vijak ø 5,0 mm: križna zarez PZ2
 - vijak ø 6,0 mm: križna zarez PZ3



Univerzalni vijak ugrezna glava T-STAR plus, Torx zarez cel navoj

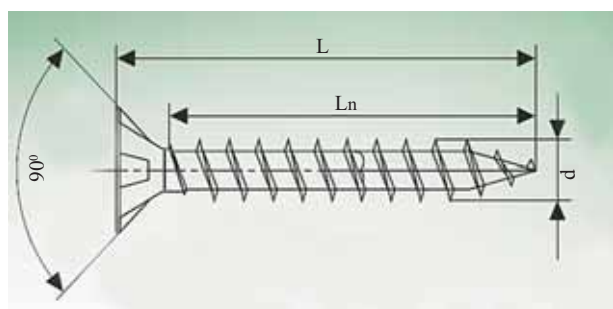

Šifra	Naziv	d (ø) mm	L mm	Ln mm
013012	Vijak Spax vgr. gl. 3,0x12 TX rumen	3,0	12	10
013013	Vijak Spax vgr. gl. 3,0x13 TX rumen	3,0	13	10
013015	Vijak Spax vgr. gl. 3,0x15 TX rumen	3,0	15	12
013016	Vijak Spax vgr. gl. 3,0x16 TX rumen	3,0	16	14
013017	Vijak Spax vgr. gl. 3,0x17 TX rumen	3,0	17	14
013020	Vijak Spax vgr. gl. 3,0x20 TX rumen	3,0	20	17
013025	Vijak Spax vgr. gl. 3,0x25 TX rumen	3,0	25	22
013515	Vijak Spax vgr. gl. 3,5x15 TX rumen	3,5	15	11
013516	Vijak Spax vgr. gl. 3,5x16 TX rumen	3,5	16	13
013520	Vijak Spax vgr. gl. 3,5x20 TX rumen	3,5	20	16
013525	Vijak Spax vgr. gl. 3,5x25 TX rumen	3,5	25	21
014013	Vijak Spax vgr. gl. 4,0x13 TX rumen	4,0	13	11
014015	Vijak Spax vgr. gl. 4,0x15 TX rumen	4,0	15	11
014016	Vijak Spax vgr. gl. 4,0x16 TX rumen	4,0	16	13
014020	Vijak Spax vgr. gl. 4,0x20 TX rumen	4,0	20	16
014025	Vijak Spax vgr. gl. 4,0x25 TX rumen	4,0	25	21

Univerzalni vijak z ugrezno glavo

- tako neverjeten, kot je videti
- univerzalna uporaba
- ugrezna glava T-STAR plus
- ojačan, sintran s plastiko
- pocinkan, rumeno pasiviran
- več moči z manjšo silo
- čisto uvijanje
- ne razceplja materiala tudi pri majhnih razdaljah od robov
- brez predhodnega vrtanja
- ugrezna glava
- hiter in enostaven za uporabo
- zarez v glavi:
 - vijak ø 3,0 mm: Torx T10
 - vijak ø 3,5 mm: Torx T15
 - vijak ø 4,0 mm: Torx T20



Univerzalni vijak ugrezna glava T-STAR plus, Torx zarez delni navoj

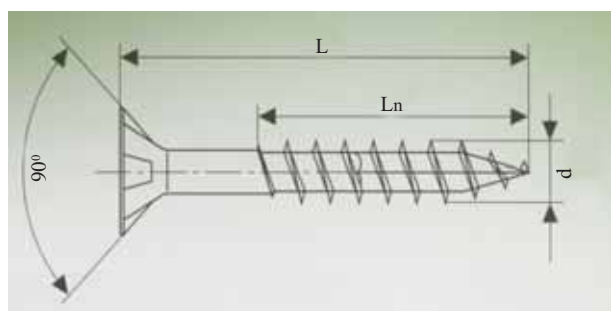

Šifra	Naziv	d (ø) mm	L mm	Ln mm
013030	Vijak Spax vgr. gl. 3,0x30 TX rumen	3,0	30	18
013035	Vijak Spax vgr. gl. 3,0x35 TX rumen	3,0	35	23
013040	Vijak Spax vgr. gl. 3,0x40 TX rumen	3,0	40	23
013530	Vijak Spax vgr. gl. 3,5x30 TX rumen	3,5	30	18
013535	Vijak Spax vgr. gl. 3,5x35 TX rumen	3,5	35	23
013540	Vijak Spax vgr. gl. 3,5x40 TX rumen	3,5	40	23
013545	Vijak Spax vgr. gl. 3,5x45 TX rumen	3,5	45	30
013550	Vijak Spax vgr. gl. 3,5x50 TX rumen	3,5	50	32
014030	Vijak Spax vgr. gl. 4,0x30 TX rumen	4,0	30	18
014035	Vijak Spax vgr. gl. 4,0x35 TX rumen	4,0	35	23
014040	Vijak Spax vgr. gl. 4,0x40 TX rumen	4,0	40	23
014045	Vijak Spax vgr. gl. 4,0x45 TX rumen	4,0	45	30
014050	Vijak Spax vgr. gl. 4,0x50 TX rumen	4,0	50	32
014060	Vijak Spax vgr. gl. 4,0x60 TX rumen	4,0	60	35
014070	Vijak Spax vgr. gl. 4,0x70 TX rumen	4,0	70	37
014525	Vijak Spax vgr. gl. 4,5x25 TX rumen	4,5	25	21
014530	Vijak Spax vgr. gl. 4,5x30 TX rumen	4,5	30	17
014535	Vijak Spax vgr. gl. 4,5x35 TX rumen	4,5	35	25
014540	Vijak Spax vgr. gl. 4,5x40 TX rumen	4,5	40	25
014545	Vijak Spax vgr. gl. 4,5x45 TX rumen	4,5	45	30
014550	Vijak Spax vgr. gl. 4,5x50 TX rumen	4,5	50	32
014560	Vijak Spax vgr. gl. 4,5x60 TX rumen	4,5	60	37
014570	Vijak Spax vgr. gl. 4,5x70 TX rumen	4,5	70	42
014580	Vijak Spax vgr. gl. 4,5x80 TX rumen	4,5	80	47

Univerzalni vijak z ugrezno glavo

- tako neverjeten, kot je videti
- univerzalna uporaba
- ugrezna glava T-STAR plus
- ojačan, sintran s plastiko
- pocinkan, rumeno pasiviran
- več moči z manjšo silo
- čisto uvijanje
- ne razceplja materiala tudi pri majhnih razdaljah od robov
- brez predhodnega vrtanja
- hiter in enostaven za uporabo
- zareza v glavi:
 - vijak ø 3,0 mm: Torx T10
 - vijak ø 3,5 mm: Torx T15
 - vijak ø 4,0 mm, ø 4,5 mm: Torx T20



Univerzalni vijak ugrezna glava T-STAR plus, Torx zarez delni navoj

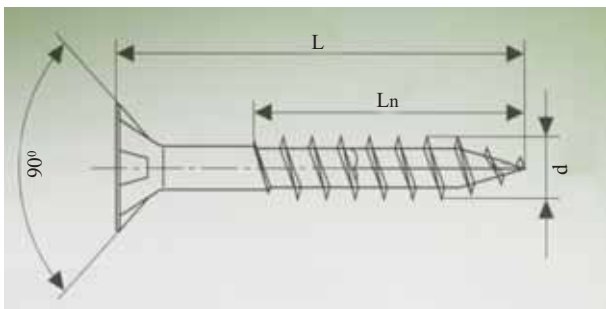

Šifra	Naziv	d (ø) mm	L mm	Ln mm
015030	Vijak Spax vgr. gl. 5,0x30 TX rumen	5,0	30	17
015035	Vijak Spax vgr. gl. 5,0x35 TX rumen	5,0	35	25
015040	Vijak Spax vgr. gl. 5,0x40 TX rumen	5,0	40	27
015045	Vijak Spax vgr. gl. 5,0x45 TX rumen	5,0	45	30
015050	Vijak Spax vgr. gl. 5,0x50 TX rumen	5,0	50	32
015055	Vijak Spax vgr. gl. 5,0x55 TX rumen	5,0	55	37
015060	Vijak Spax vgr. gl. 5,0x60 TX rumen	5,0	60	37
015070	Vijak Spax vgr. gl. 5,0x70 TX rumen	5,0	70	41
015080	Vijak Spax vgr. gl. 5,0x80 TX rumen	5,0	80	46
015090	Vijak Spax vgr. gl. 5,0x90 TX rumen	5,0	90	61
015100	Vijak Spax vgr. gl. 5,0x100 TX rumen	5,0	100	61
016040	Vijak Spax vgr. gl. 6,0x40 TX rumen	6,0	40	24
016050	Vijak Spax vgr. gl. 6,0x50 TX rumen	6,0	50	32
016060	Vijak Spax vgr. gl. 6,0x60 TX rumen	6,0	60	37
016070	Vijak Spax vgr. gl. 6,0x70 TX rumen	6,0	70	41
016080	Vijak Spax vgr. gl. 6,0x80 TX rumen	6,0	80	46
016090	Vijak Spax vgr. gl. 6,0x90 TX rumen	6,0	90	61
016100	Vijak Spax vgr. gl. 6,0x100 TX rumen	6,0	100	61
016110	Vijak Spax vgr. gl. 6,0x110 TX rumen	6,0	110	68
016120	Vijak Spax vgr. gl. 6,0x120 TX rumen	6,0	120	68
016130	Vijak Spax vgr. gl. 6,0x130 TX rumen	6,0	130	68
016140	Vijak Spax vgr. gl. 6,0x140 TX rumen	6,0	140	68
016150	Vijak Spax vgr. gl. 6,0x150 TX rumen	6,0	150	68
S štirikotnim rezkarjem 4 CUT				
016160	Vijak Spax vgr. gl. 6,0x160 TX rumen	6,0	160	65
016180	Vijak Spax vgr. gl. 6,0x180 TX rumen	6,0	180	65

Univerzalni vijak z ugrezno glavo

- tako neverjeten, kot je videti
- univerzalna uporaba
- ugrezna glava T-STAR plus
- ojačan, sintran s plastiko
- pocinkan, rumeno pasiviran
- več moči z manjšo silo
- čisto uvijanje
- ne razceplja materiala tudi pri majhnih razdaljah od robov
- brez predhodnega vrtanja
- hiter in enostaven za uporabo
- zarez v glavi:
 - vijak ø 5,0 mm: Torx T20
 - vijak ø 6,0 mm: Torx T30



Univerzalni vijak - lečasta ugrezna glava križna zarez PZ, cel navoj

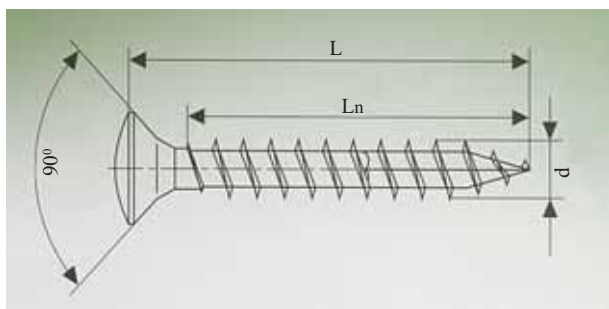
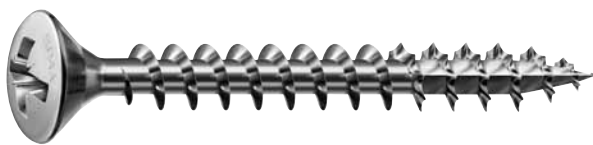

Šifra	Naziv	d (ø) mm	L mm	Ln mm
033015	Vijak Spax lečasta glava 3,0x15 mm bel	3,0	15	10
033017	Vijak Spax lečasta glava 3,0x17 mm bel	3,0	17	13
033020	Vijak Spax lečasta glava 3,0x20 mm bel	3,0	20	16
033025	Vijak Spax lečasta glava 3,0x25 mm bel	3,0	25	21
033030	Vijak Spax lečasta glava 3,0x30 mm bel	3,0	30	26
033515	Vijak Spax lečasta glava 3,5x15 mm bel	3,5	15	11
033516	Vijak Spax lečasta glava 3,5x16 mm bel	3,5	16	13
033517	Vijak Spax lečasta glava 3,5x17 mm bel	3,5	17	13
033520	Vijak Spax lečasta glava 3,5x20 mm bel	3,5	20	16
033525	Vijak Spax lečasta glava 3,5x25 mm bel	3,5	25	21
033530	Vijak Spax lečasta glava 3,5x30 mm bel	3,5	30	25
033535	Vijak Spax lečasta glava 3,5x35 mm bel	3,5	35	30
033540	Vijak Spax lečasta glava 3,5x40 mm bel	3,5	40	35
034015	Vijak Spax lečasta glava 4,0x15 mm bel	4,0	15	11
034016	Vijak Spax lečasta glava 4,0x16 mm bel	4,0	16	13
034017	Vijak Spax lečasta glava 4,0x17 mm bel	4,0	17	13
034020	Vijak Spax lečasta glava 4,0x20 mm bel	4,0	20	16
034025	Vijak Spax lečasta glava 4,0x25 mm bel	4,0	25	21
034030	Vijak Spax lečasta glava 4,0x30 mm bel	4,0	30	25
034035	Vijak Spax lečasta glava 4,0x35 mm bel	4,0	35	30
034040	Vijak Spax lečasta glava 4,0x40 mm bel	4,0	40	35
034045	Vijak Spax lečasta glava 4,0x45 mm bel	4,0	45	40
034050	Vijak Spax lečasta glava 4,0x50 mm bel	4,0	50	45

Univerzalni vijak z lečasto ugrezno glavo

- univerzalna uporaba
- lečasta ugrezna glava
- belo cinkan
- ojačan, sintran s plastiko
- čisto uvijanje
- ne razceplja materiala tudi pri majhnih razdaljah od robov
- brez predhodnega vrtanja
- več moči z manjšo silo
- hiter in enostaven za uporabo
- zarez v glavi:
 - vijak ø 3,0 mm: križna zarez PZ1
 - vijak ø 3,5 mm, ø 4,0 mm: križna zarez PZ2



Univerzalni vijak - lečasta ugrezna glava križna zarez PZ, cel navoj

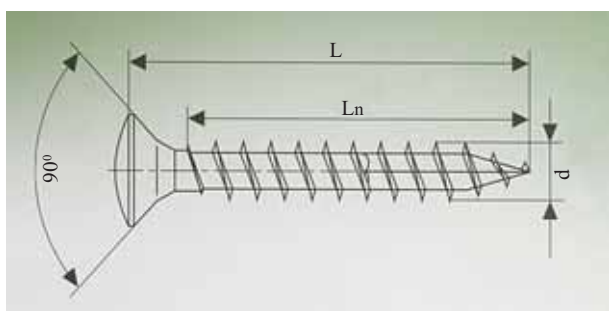

Šifra	Naziv	d (ø) mm	L mm	Ln mm
034515	Vijak Spax lečasta glava 4,5x15 mm bel	4,5	15	11
034517	Vijak Spax lečasta glava 4,5x17 mm bel	4,5	17	13
034525	Vijak Spax lečasta glava 4,5x25 mm bel	4,5	25	21
034530	Vijak Spax lečasta glava 4,5x30 mm bel	4,5	30	25
034535	Vijak Spax lečasta glava 4,5x35 mm bel	4,5	35	30
034535	Vijak Spax lečasta glava 4,5x35 mm bel	4,5	35	30
034540	Vijak Spax lečasta glava 4,5x40 mm bel	4,5	40	34
034545	Vijak Spax lečasta glava 4,5x45 mm bel	4,5	45	39
034550	Vijak Spax lečasta glava 4,5x50 mm bel	4,5	50	44
035035	Vijak Spax lečasta glava 5,0x35 mm bel	5,0	35	30
035040	Vijak Spax lečasta glava 5,0x40 mm bel	5,0	40	35
035045	Vijak Spax lečasta glava 5,0x45 mm bel	5,0	45	39
035050	Vijak Spax lečasta glava 5,0x50 mm bel	5,0	50	44
035060	Vijak Spax lečasta glava 5,0x60 mm bel	5,0	60	54

Univerzalni vijak z lečasto ugrezno glavo

- univerzalna uporaba
- lečasta ugrezna glava
- belo cinkan
- ojačan, sintran s plastiko
- čisto uvijanje
- ne razceplja materiala tudi pri majhnih razdaljah od robov
- brez predhodnega vrtanja
- več moči z manjšo silo
- hiter in enostaven za uporabo
- zarez v glavi: križna zarez PZ2



Univerzalni vijak - bombirana glava križna zarez PZ, cel navoj

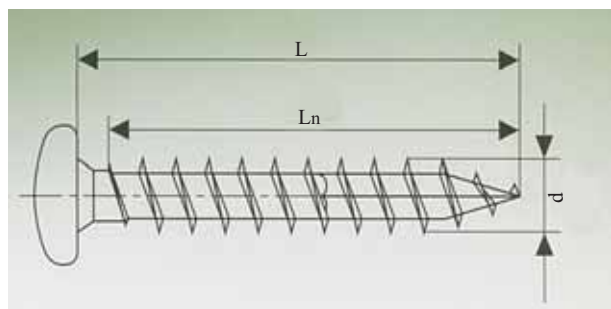

Šifra	Naziv	d (ø) mm	L mm	Ln mm
023010	Vijak Spax bombirana glava 3,0x10 bel	3,0	10	8
023012	Vijak Spax bombirana glava 3,0x12 bel	3,0	12	11
023013	Vijak Spax bombirana glava 3,0x13 bel	3,0	13	11
023015	Vijak Spax bombirana glava 3,0x15 bel	3,0	15	13
023016	Vijak Spax bombirana glava 3,0x16 bel	3,0	16	15
023017	Vijak Spax bombirana glava 3,0x17 bel	3,0	17	15
023020	Vijak Spax bombirana glava 3,0x20 bel	3,0	20	18
023025	Vijak Spax bombirana glava 3,0x25 bel	3,0	25	23
023030	Vijak Spax bombirana glava 3,0x30 bel	3,0	30	28
023510	Vijak Spax bombirana glava 3,5x10 bel	3,5	10	8
023512	Vijak Spax bombirana glava 3,5x12 bel	3,5	12	11
023513	Vijak Spax bombirana glava 3,5x13 bel	3,5	13	11
023515	Vijak Spax bombirana glava 3,5x15 bel	3,5	15	13
023517	Vijak Spax bombirana glava 3,5x17 bel	3,5	17	15
023520	Vijak Spax bombirana glava 3,5x20 bel	3,5	20	18
023525	Vijak Spax bombirana glava 3,5x25 bel	3,5	25	23
023530	Vijak Spax bombirana glava 3,5x30 bel	3,5	30	27
023535	Vijak Spax bombirana glava 3,5x35 bel	3,5	35	32
023540	Vijak Spax bombirana glava 3,5x40 bel	3,5	40	37
023545	Vijak Spax bombirana glava 3,5x45 bel	3,5	45	42
024012	Vijak Spax bombirana glava 4,0x12 bel	4,0	12	11
024013	Vijak Spax bombirana glava 4,0x13 bel	4,0	13	11
024015	Vijak Spax bombirana glava 4,0x15 bel	4,0	15	13
024016	Vijak Spax bombirana glava 4,0x16 bel	4,0	16	15
024017	Vijak Spax bombirana glava 4,0x17 bel	4,0	17	15
024020	Vijak Spax bombirana glava 4,0x20 bel	4,0	20	18
024025	Vijak Spax bombirana glava 4,0x25 bel	4,0	25	23
024030	Vijak Spax bombirana glava 4,0x30 bel	4,0	30	27
024035	Vijak Spax bombirana glava 4,0x35 bel	4,0	35	32
024040	Vijak Spax bombirana glava 4,0x40 bel	4,0	40	37
024045	Vijak Spax bombirana glava 4,0x45 bel	4,0	45	42
024050	Vijak Spax bombirana glava 4,0x50 bel	4,0	50	47

Univerzalni vijak z bombirano glavo

- univerzalna uporaba
- bombirana glava
- belo cinkan
- ojačan, sintran s plastiko
- čisto uvijanje
- ne razceplja materiala tudi pri majhnih razdaljah od robov
- brez predhodnega vrtanja
- več moči z manjšo silo
- hiter in enostaven za uporabo
- zareza v glavi:
 - vijak ø 3,0 mm: križna zarez PZ1
 - vijak ø 3,5 mm, ø 4,0 mm: križna zarez PZ2



Univerzalni vijak - bombirana glava križna zareza PZ, cel navoj

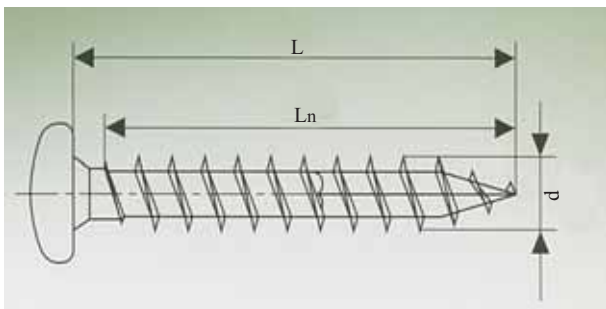

Šifra	Naziv	d (ø) mm	L mm	Ln mm
024512	Vijak Spax bombirana glava 4,5x12 bel	4,5	12	11
024515	Vijak Spax bombirana glava 4,5x15 bel	4,5	15	13
024516	Vijak Spax bombirana glava 4,5x16 bel	4,5	16	15
024517	Vijak Spax bombirana glava 4,5x17 bel	4,5	17	15
024520	Vijak Spax bombirana glava 4,5x20 bel	4,5	20	17
024525	Vijak Spax bombirana glava 4,5x25 bel	4,5	25	22
024530	Vijak Spax bombirana glava 4,5x30 bel	4,5	30	27
024535	Vijak Spax bombirana glava 4,5x35 bel	4,5	35	32
024540	Vijak Spax bombirana glava 4,5x40 bel	4,5	40	37
024545	Vijak Spax bombirana glava 4,5x45 bel	4,5	45	42
024550	Vijak Spax bombirana glava 4,5x50 bel	4,5	50	47
025016	Vijak Spax bombirana glava 5,0x16 bel	5,0	16	12
025017	Vijak Spax bombirana glava 5,0x17 bel	5,0	17	14
025020	Vijak Spax bombirana glava 5,0x20 bel	5,0	20	17
025025	Vijak Spax bombirana glava 5,0x25 bel	5,0	25	22
025030	Vijak Spax bombirana glava 5,0x30 bel	5,0	30	27
025035	Vijak Spax bombirana glava 5,0x35 bel	5,0	35	32
025040	Vijak Spax bombirana glava 5,0x40 bel	5,0	40	37
025045	Vijak Spax bombirana glava 5,0x45 bel	5,0	45	41
025050	Vijak Spax bombirana glava 5,0x50 bel	5,0	50	46
025060	Vijak Spax bombirana glava 5,0x60 bel	5,0	60	56
025070	Vijak Spax bombirana glava 5,0x70 bel	5,0	70	61
025080	Vijak Spax bombirana glava 5,0x80 bel	5,0	80	61
026035	Vijak Spax bombirana glava 6,0x35 bel	6,0	35	32
026040	Vijak Spax bombirana glava 6,0x40 bel	6,0	40	37
026045	Vijak Spax bombirana glava 6,0x45 bel	6,0	45	41
026050	Vijak Spax bombirana glava 6,0x50 bel	6,0	50	46
026060	Vijak Spax bombirana glava 6,0x60 bel	6,0	60	56
026070	Vijak Spax bombirana glava 6,0x70 bel	6,0	70	61
026080	Vijak Spax bombirana glava 6,0x80 bel	6,0	80	61
026090	Vijak Spax bombirana glava 6,0x90 bel	6,0	90	61
026100	Vijak Spax bombirana glava 6,0x100 bel	6,0	100	61

Univerzalni vijak z bombirano glavo

- univerzalna uporaba
- bombirana glava
- belo cinkan
- ojačan, sintran s plastiko
- čisto uvijanje
- ne razceplja materiala tudi pri majhnih razdaljah od robov
- brez predhodnega vrtanja
- več moči z manjšo silo
- hiter in enostaven za uporabo
- zarez v glavi:
 - vijak ø 4,5 mm, ø 5,0 mm: križna zareza PZ2
 - vijak ø 6,0 mm: križna zareza PZ3



Višja fleksibilnost

Zaradi univerzalne uporabnosti

**Tako neverjeten
kot je videti**

Prednosti

- univerzalno uporaben
- ne razceplja materiala
- brez predhodnega vrtanja
- hiter in enostaven za uporabo





Univerzalni vijak - ugrezna glava - Inox križna zareza PZ, cel navoj



- Multi glava
- preprosto ugreznanje
- rezka v les
- zavira na kovini
- Dolžina navoja
odvisna od
velikosti vijaka
- Spodnji zobati
navoj omogoča
lahko vijachenje
v material
- 4 CUT konica
- brez predvrtanja
- brez razcepljanja

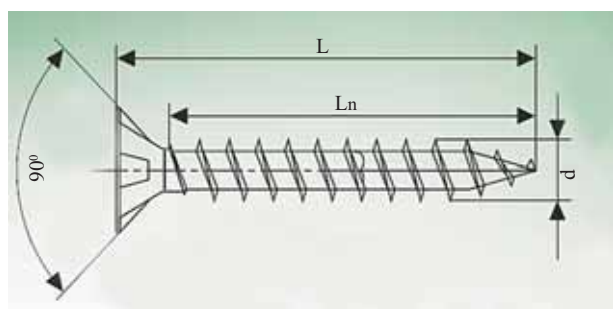

Šifra	Naziv	d (ø) mm	L mm	Ln mm
053012	Vijak Spax vgrezna glava 3,0x12 A2	3,0	12	10
053016	Vijak Spax vgrezna glava 3,0x16 A2	3,0	16	13
053020	Vijak Spax vgrezna glava 3,0x20 A2	3,0	20	16
053025	Vijak Spax vgrezna glava 3,0x25 A2	3,0	25	21
053030	Vijak Spax vgrezna glava 3,0x30 A2	3,0	30	26
053035	Vijak Spax vgrezna glava 3,0x35 A2	3,0	35	31
053040	Vijak Spax vgrezna glava 3,0x40 A2	3,0	40	36
053516	Vijak Spax vgrezna glava 3,5x16 A2	3,5	16	13
053520	Vijak Spax vgrezna glava 3,5x20 A2	3,5	20	16
053525	Vijak Spax vgrezna glava 3,5x25 A2	3,5	25	21
053530	Vijak Spax vgrezna glava 3,5x30 A2	3,5	30	25
053535	Vijak Spax vgrezna glava 3,5x35 A2	3,5	35	30
053540	Vijak Spax vgrezna glava 3,5x40 A2	3,5	40	35
054020	Vijak Spax vgrezna glava 4,0x20 A2	4,0	20	16
054025	Vijak Spax vgrezna glava 4,0x25 A2	4,0	25	21
054030	Vijak Spax vgrezna glava 4,0x30 A2	4,0	30	25
054035	Vijak Spax vgrezna glava 4,0x35 A2	4,0	35	30
054040	Vijak Spax vgrezna glava 4,0x40 A2	4,0	40	35
054045	Vijak Spax vgrezna glava 4,0x45 A2	4,0	45	40
054050	Vijak Spax vgrezna glava 4,0x50 A2	4,0	50	45
054530	Vijak Spax vgrezna glava 4,5x30 A2	4,5	30	25
054535	Vijak Spax vgrezna glava 4,5x35 A2	4,5	35	30
054540	Vijak Spax vgrezna glava 4,5x40 A2	4,5	40	34
054545	Vijak Spax vgrezna glava 4,5x45 A2	4,5	45	39
054550	Vijak Spax vgrezna glava 4,5x50 A2	4,5	50	44

Univerzalni vijak z ugrezno glavo - Inox

- univerzalno uporaben za les, pločevino in umetne mase
- tako neverjeten, kot je videti
- več moči z manjšo silo
- čisto uvijanje
- ne razceplja materiala tudi pri majhnih razdaljah od robov
- brez predhodnega vrtanja
- nerjaveče legirano jeklo A2
- brez rjastih sledi
- brez zarjavelih glav vijakov
- ugrezna glava
- sintran s plastiko
- univerzalna uporaba
- hiter in enostaven za uporabo
- zarez v glavi:
 - vijak ø 3,0 mm: križna zareza PZ1
 - vijak ø 3,5 mm, ø 4,0 mm, ø 4,5 mm: križna zareza PZ2



Univerzalni vijak - ugrezna glava - Inox križna zareza PZ, cel navoj

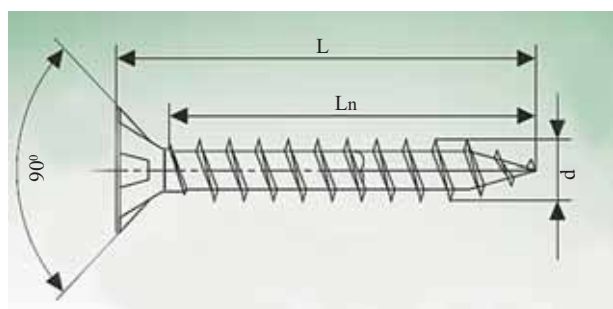

Šifra	Naziv	d (ø) mm	L mm	Ln mm
055030	Vijak Spax vgrezna glava 5,0x30 A2	5,0	30	25
055035	Vijak Spax vgrezna glava 5,0x35 A2	5,0	35	30
055040	Vijak Spax vgrezna glava 5,0x40 A2	5,0	40	35
055045	Vijak Spax vgrezna glava 5,0x45 A2	5,0	45	39
055050	Vijak Spax vgrezna glava 5,0x50 A2	5,0	50	44
055060	Vijak Spax vgrezna glava 5,0x60 A2	5,0	60	54
055070	Vijak Spax vgrezna glava 5,0x70 A2	5,0	70	61
055080	Vijak Spax vgrezna glava 5,0x80 A2	5,0	80	61
055090	Vijak Spax vgrezna glava 5,0x90 A2	5,0	90	61
056040	Vijak Spax vgrezna glava 6,0x40 A2	6,0	40	34
056050	Vijak Spax vgrezna glava 6,0x50 A2	6,0	50	43
056060	Vijak Spax vgrezna glava 6,0x60 A2	6,0	60	53
056070	Vijak Spax vgrezna glava 6,0x70 A2	6,0	70	61
056080	Vijak Spax vgrezna glava 6,0x80 A2	6,0	80	61
056090	Vijak Spax vgrezna glava 6,0x90 A2	6,0	90	61
056100	Vijak Spax vgrezna glava 6,0x100 A2	6,0	100	61

Univerzalni vijak z ugrezno glavo - Inox

- tako neverjeten, kot je videti
- univerzalna uporaba
- ugrezna glava
- sintran s plastiko
- čisto uvijanje
- ne razceplja materiala tudi pri majhnih razdaljah od robov
- brez predhodnega vrtanja
- nerjaveče legirano jeklo A2
- brez rjastih sledi
- brez zarjavelih glav vijakov
- več moči z manjšo silo
- hiter in enostaven za uporabo
- zarez v glavi:
 - vijak ø 5,0 mm: križna zareza PZ2
 - vijak ø 6,0 mm: križna zareza PZ3



Vijak za lesno gradnjo
Novo merilo za varnost in
gospodarnost

**Tako neverjeten
kot je videti**

Prednosti

- zanesljiv
- ekonomičen
- brez predvrtanja
- visok prenos moči s T-STAR glavo
- za maksimalne natezne in pritisne sile



Vijak za lesno gradnjo ugrezna in krožna glava T-STAR plus Torx zareza, delni navoj



Vijak SPAX za lesene gradbene konstrukcije

- ojačan, sintran s plastiko
- glava T-STAR plus
- hitro in učinkovito spajanje gradbenih konstrukcij
- optimalen profil navoja - točno v sredini konice
- učinkovito uvijanje v material, brez razcepljanja lesa
- odlično prileganje in boljše vijačenje z novim sistemom za vijačni nastavek
- multifunkcijska glava za lepše uvijanje v les
- nazobčani in sintetično prevlečeni spodnji del navoja omogoča spajanje z manjšim navorom
- predhodno vrtnanje ni potrebno, kar omogoča hitro spajanje elementov
- prihranek časa in denarja
- pri krožni glavi vijak omogoča veliko obremenitev tudi v primeru velike natezne sile
- krožna glava omogoča večjo trdnost spoja od ugrezne, kar pomeni večjo razdaljo med vijaki za isto obremenitev
- dolžina vijaka in proizvajalec vtisnjena v glavi vijaka
- navoj \varnothing 8 in \varnothing 10 mm, dolžina navoja odvisna od dolžine vijaka
- zareza v glavi:
vijak \varnothing 8 mm: Torx T40
vijak \varnothing 10 mm: Torx T50



Ugrezna glava T-STAR plus:

- vijaki \varnothing 8x80 do \varnothing 8x400 mm



Povečana krožna glava T-STAR plus:

- vijaki \varnothing 8x80 do \varnothing 8x400 mm
- vijaki \varnothing 10x200 do \varnothing 10x400 mm



Izpopolnjen navoj:

- za hitro in varno privijanje



Konica 4 CUT:

- brez predvrtanja
- učinkovito zmanjšuje razpoke
- štirikotna konica ločuje vlakna



Multifunkcijska glava:

- tesno prilegajoč ugrez
- rezka v les in zavira na kovini
- dolžina vijaka in proizvajalec vtisnjena v glavi vijaka





Vijak za lesno gradnjo ugrezna glava T-STAR plus Torx zarez, delni navoj



ugrezna glava T-STAR plus

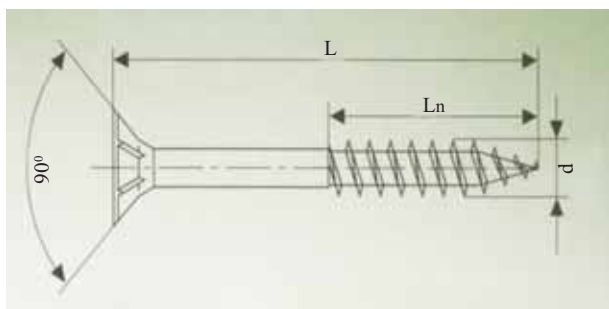

Šifra	Naziv	d (ø) mm	L mm	Ln mm
018080	Vijak Spax vgrezna glava 8,0x80 tx rumen	8,0	80	47
018100	Vijak Spax vgrezna glava 8,0x100 tx rumen	8,0	100	57
018120	Vijak Spax vgrezna glava 8,0x120 tx rumen	8,0	120	70
018140	Vijak Spax vgrezna glava 8,0x140 tx rumen	8,0	140	80
S štirikotnim rezkarjem 4 CUT				
018160	Vijak Spax vgrezna glava 8,0x160 tx rumen	8,0	160	80
018180	Vijak Spax vgrezna glava 8,0x180 tx rumen	8,0	180	80
018200	Vijak Spax vgrezna glava 8,0x200 tx rumen	8,0	200	80
018220	Vijak Spax vgrezna glava 8,0x220 tx rumen	8,0	220	80
018240	Vijak Spax vgrezna glava 8,0x240 tx rumen	8,0	240	80
018260	Vijak Spax vgrezna glava 8,0x260 tx rumen	8,0	260	80
018280	Vijak Spax vgrezna glava 8,0x280 tx rumen	8,0	280	80
018300	Vijak Spax vgrezna glava 8,0x300 tx rumen	8,0	300	80
018320	Vijak Spax vgrezna glava 8,0x320 tx rumen	8,0	320	80
018340	Vijak Spax vgrezna glava 8,0x340 tx rumen	8,0	340	80
018360	Vijak Spax vgrezna glava 8,0x360 tx rumen	8,0	360	80
018380	Vijak Spax vgrezna glava 8,0x380 tx rumen	8,0	380	80
018400	Vijak Spax vgrezna glava 8,0x400 tx rumen	8,0	400	80

Vijak za lesno gradnjo

- multifunkcijska ugrezna glava T-STAR plus
- ojačan, sintran s plastiko
- pocinkan, rumeno pasiviran
- konica 4 CUT:
 - brez predvrtanja
 - učinkovito zmanjšuje razpoke
 - štirikotna konica ločuje vlakna
- izpopolnjen valovit profil vse do konice za hitro in varno privijanje
- štirikotni rezkar 4 CUT od dolžine vijaka 160 mm dalje občutno zmanjšuje vrtilni moment privijanja
- T-STAR plus
 - čisti sedež nastavka in boljše vodenje vijaka
- zarez v glavi: Torx T40
- tehnično soglasje:
 - Z-9.1-449 kot vezni element za les
 - Z-9.1-511 za strešno izolacijo



Vijak za lesno gradnjo krožna glava T-STAR plus Torx zareza, delni navoj



povečana krožna glava T-STAR plus

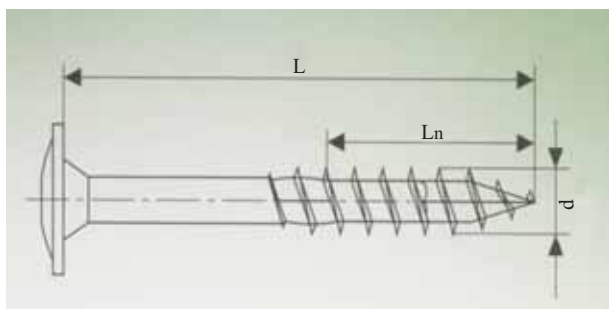

Šifra	Naziv	d (ø) mm	L mm	Ln mm
018081	Vijak Spax krožna glava 8,0x80 tx rumen	8,0	80	70
018101	Vijak Spax krožna glava 8,0x100 tx rumen	8,0	100	80
018121	Vijak Spax krožna glava 8,0x120 tx rumen	8,0	120	80
018141	Vijak Spax krožna glava 8,0x140 tx rumen	8,0	140	80
S štirikotnim rezkarjem 4 CUT				
018161	Vijak Spax krožna glava 8,0x160 tx rumen	8,0	160	80
018181	Vijak Spax krožna glava 8,0x180 tx rumen	8,0	180	80
018201	Vijak Spax krožna glava 8,0x200 tx rumen	8,0	200	80
018221	Vijak Spax krožna glava 8,0x220 tx rumen	8,0	220	80
018241	Vijak Spax krožna glava 8,0x240 tx rumen	8,0	240	80
018261	Vijak Spax krožna glava 8,0x260 tx rumen	8,0	260	80
018281	Vijak Spax krožna glava 8,0x280 tx rumen	8,0	280	80
018301	Vijak Spax krožna glava 8,0x300 tx rumen	8,0	300	80
018321	Vijak Spax krožna glava 8,0x320 tx rumen	8,0	320	80
018341	Vijak Spax krožna glava 8,0x340 tx rumen	8,0	340	80
018361	Vijak Spax krožna glava 8,0x360 tx rumen	8,0	360	80
018381	Vijak Spax krožna glava 8,0x380 tx rumen	8,0	380	80
018401	Vijak Spax krožna glava 8,0x400 tx rumen	8,0	400	80
011020	Vijak Spax krožna glava 10,0x200 tx rumen	10,0	200	80
011022	Vijak Spax krožna glava 10,0x220 tx rumen	10,0	220	80
011024	Vijak Spax krožna glava 10,0x240 tx rumen	10,0	240	80
011026	Vijak Spax krožna glava 10,0x260 tx rumen	10,0	260	80
011028	Vijak Spax krožna glava 10,0x280 tx rumen	10,0	280	80
011030	Vijak Spax krožna glava 10,0x300 tx rumen	10,0	300	80
011032	Vijak Spax krožna glava 10,0x320 tx rumen	10,0	320	80
011034	Vijak Spax krožna glava 10,0x340 tx rumen	10,0	340	80
011036	Vijak Spax krožna glava 10,0x360 tx rumen	10,0	360	80
011038	Vijak Spax krožna glava 10,0x380 tx rumen	10,0	380	80
011040	Vijak Spax krožna glava 10,0x400 tx rumen	10,0	400	80

Vijak za lesno gradnjo

- povečana krožna glava T-STAR plus
- ojačan, sintran s plastiko
- pocinkan, rumeno pasiviran
- konica 4 CUT
brez predvrtanja
učinkovito zmanjšuje razpoke
štirikotna konica ločuje vlakna
- izpopolnjen valovit profil vse do konice za hitro in varno privijanje
- štirikotni rezkar 4 CUT od dolžine vijaka 160 mm dalje občutno zmanjšuje vrtilni moment privijanja
- povečana oblika glave za večjo silo spajanja in večje razdalje med vijaki
- T-STAR plus: čisti sedež nastavka in boljše vodenje vijaka
- zareza v glavi:
vijak ø 8 mm: Torx T40, vijak ø 10 mm: Torx T50
- tehnično soglasje:
Z-9.1-449 kot vezni element za les
Z-9.1-511 za strešno izolacijo



SPAX[®]-D

Idealni vijak za
Lesene terase

**Konica
CUT**

A2

NOVO

Prednosti

- varen sedež lesene obloge na podkonstrukcijo
- tesno privitje skupaj - učinek primeža
- lahko privijanje tudi pri trdem lesu*

* pri trdem lesu priporočamo predhodno vrtanje



INOX
STAINLESS STEEL



Vijak za lesene terase - SPAX-D glava T-STAR plus, Torx zarez

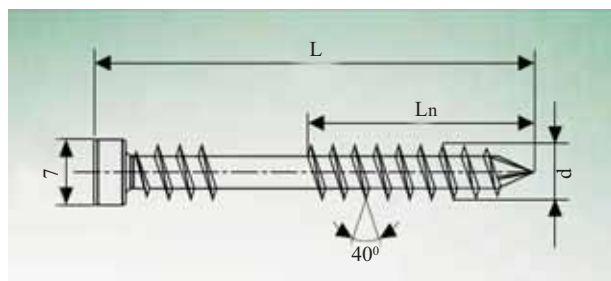

Šifra	Naziv	d (ø) mm	L mm	Ln mm
064130	Vijak Spax-D 5,0x40 delni navoj Torx A2	5,0	40	22,5
064131	Vijak Spax-D 5,0x50 delni navoj Torx A2	5,0	50	22,5
064132	Vijak Spax-D 5,0x60 delni navoj Torx A2	5,0	60	27,5
064133	Vijak Spax-D 5,0x70 delni navoj Torx A2	5,0	70	32,5
064134	Vijak Spax-D 5,0x80 delni navoj Torx A2	5,0	80	37,5

Vijak SPAX za lesene terase

- spodnji del vijaka brez navoja omogoča močno stisnjenost dveh materialov
- navoj pri glavi vijaka omogoča močno in varno pričvrstitev desk na podlago
- z rezalnimi rebri in konico CUT, ki preprečuje razcepljanje materiala
- brez predvrtnja
- glava T-STAR plus
- nerjaveče legirano jeklo A2
- brez rjastih sledi
- brez zarjavelih glav vijakov
- sintran s plastiko
- hitra in čista montaža
- premer glave: \varnothing 7 mm
- zarez v glavi: Torx T25



Idealni vijak za
Lesene fasade

**Tehnično
soglasje**

**Konica
CUT**

Prednosti

- ne razceplja in ne razteguje materiala
- lahko in močno privitje s patentiranim valovitim profilom
- čisti ugrez zaradi rezkanih reber
- brez rje na fasadi



INOX
STAINLESS STEEL



**Vijak za lesene fasade
ugreznjena glava T-STAR plus
Torx zareza, delni navoj**

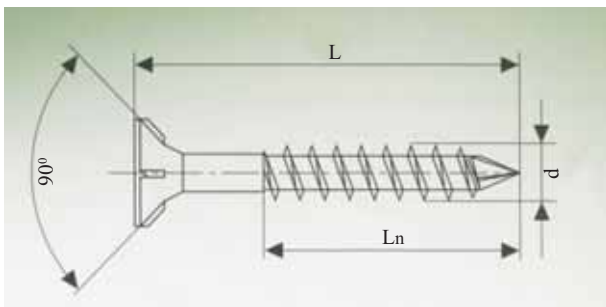

Šifra	Naziv	d (ø) mm	L mm	Ln mm
054536	Vijak Spax T-Star 4,5x35 TX A2	4,5	35	25
054541	Vijak Spax T-Star 4,5x40 TX A2	4,5	40	25
054546	Vijak Spax T-Star 4,5x45 TX A2	4,5	45	30
054551	Vijak Spax T-Star 4,5x50 TX A2	4,5	50	32
054660	Vijak Spax T-Star 4,5x60 TX A2	4,5	60	37
054770	Vijak Spax T-Star 4,5x70 TX A2	4,5	70	42
055061	Vijak Spax T-Star 5,0x60 TX A2	5,0	60	37
055071	Vijak Spax T-Star 5,0x70 TX A2	5,0	70	52
055081	Vijak Spax T-Star 5,0x80 TX A2	5,0	80	61

Vijak SPAX za lesene fasade

- ne razceplja in ne razteguje lesa
- ugreznjena glava T-STAR plus
- lahko in močno privitje s patentiranim valovitim profilom
- čisti ugrez zaradi rezkalnih reber
- privitje natančno v točko s posebno oblikovano konico CUT
- brez predhodnega vrtanja v mehak les
- material: nerjaveče legirano jeklo A2
- sintran s plastiko
- brez rje na fasadi
- brez zarjavelih glav vijakov
- zareza v glavi:
 - vijak ø 4,5 mm: Torx T20
 - vijak ø 5,0 mm: Torx T25



Idealni vijak za
Tla iz masivnega lesa

Prednosti

- lahko se ugrezne
- vijak prime takoj
- kratek čas vijačenja
- ne razceplja materiala

**Brez
predvrtanja**



Vijak za tla iz masivnega lesa
vitka ugrezna glava T-STAR plus
Torx zareza, delni navoj

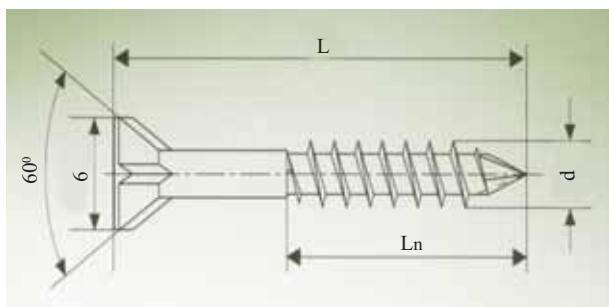

Šifra	Naziv	d (ø) mm	L mm	Ln mm
073545	Vijak Spax 3,5x45 za masivo TX gl.	3,5	45	29
073555	Vijak Spax 3,5x55 za masivo TX gl.	3,5	55	36

Vijak Spax za tla iz masivnega lesa

- vitka glava
- konica CUT
- razkalna rebra
- ugrezna glava T-STAR plus
- ojačan, sintran s plastiko
- ne razceplja materiala
- brez predvrtanja
- lahek ugrez
- vijak prime takoj
- kratek čas vijačenja
- idealen vijak za polaganje tal iz masivnega lesa
- nizek zatezni moment, krajši čas privijanja s patentiranim valovitim profilom
- visoka trdnost navojnega rezila in trdo jedro vijaka omogočata močan preboj v material
- izpopolnjena geometrija glave skrbi za varen sedež nastavka, močan oprijem in dolgo življenjsko dobo nastavka
- premer glave: ø 6 mm
- zareza v glavi: Torx T10



SPAX[®]-M

Varna pritrditev materialov
Mediapan MDF

**Brez
predvrtnja**

Prednosti

- brez predvrtnja
- ne razceplja in ne razteguje materiala
- privitje natančno v točko s posebno konico CUT



Vijak za mediapan MDF - SPAX-M
vitka ugrezna glava T-STAR plus
Torx zareza, delni navoj

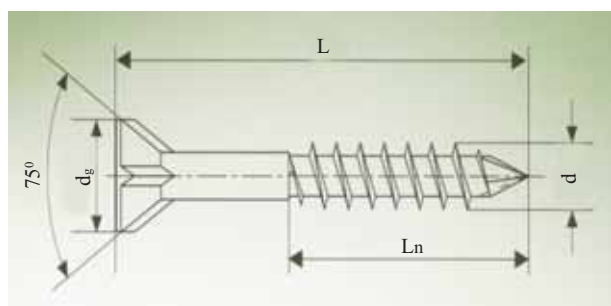

Šifra	Naziv	d (ø) mm	L mm	Ln mm
064110	Vijak Spax-M za MDF 3,5x45 beli cink	3,5	45	30
064111	Vijak Spax-M za MDF 3,5x50 beli cink	3,5	50	35
064112	Vijak Spax-M za MDF 4,0x40 beli cink	4,0	40	28
064113	Vijak Spax-M za MDF 4,0x45 beli cink	4,0	45	30
064114	Vijak Spax-M za MDF 4,0x50 beli cink	4,0	50	35
064115	Vijak Spax-M za MDF 4,0x60 beli cink	4,0	60	40
064116	Vijak Spax-M za MDF 4,5x45 beli cink	4,5	45	30
064117	Vijak Spax-M za MDF 4,5x50 beli cink	4,5	50	35

Vijak za posebno uporabo pri materialih mediapan MDF in posebno tankih ploščah iz lesenih materialov

- s konico CUT
- poboljšan, sintran s plastiko
- belo pocinkan
- ne razceplja in ne razteguje materiala MDF
- geometrija vijaka omogoča privijanje materialov MDF in posebnih tankih plošč brez predvrtanja
- posebno oblikovana konica CUT zagotavlja privitje natančno v točko
- vitka ugrezna glava z rezkanimi rebri se z lahkoto ugrezne v material
- premer glave d_g :
 vijak \varnothing 4,0 mm: \varnothing 7,0 mm
 vijak \varnothing 4,5 mm: \varnothing 8,0 mm
- zareza v glavi:
 vijak \varnothing 3,5 mm: Torx T15
 vijak \varnothing 4,0 mm, \varnothing 4,5 mm: Torx T20



Idealni vijak za
Hrbtišče

Prednosti

- posebna oblika glave
- privitje natančno v točko s posebno konico CUT
- brez predvrtnja



Vijak za hrbtišče, glava za hrbtišče križna zarez PZ

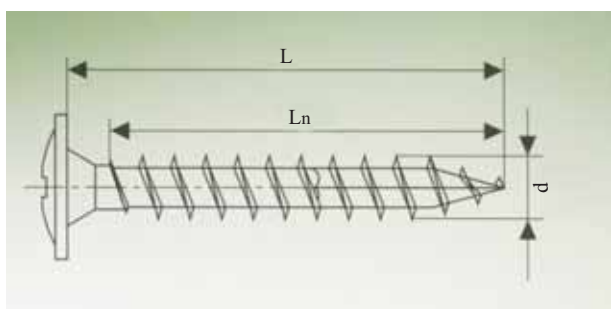

Šifra	Naziv	d (ø) mm	L mm	Ln mm
150399	Vijak za hrbtišče 3,5x17 beli cink	3,5	17	15
150235	Vijak za hrbtišče 3,5x20 beli cink	3,5	20	18
150230	Vijak za hrbtišče 3,5x25 beli cink	3,5	25	23
150231	Vijak za hrbtišče 3,5x30 beli cink	3,5	30	27
150233	Vijak za hrbtišče 3,5x35 beli cink	3,5	35	32
150237	Vijak za hrbtišče 4,0x17 beli cink	4,0	17	15
150234	Vijak za hrbtišče 4,0x20 beli cink	4,0	20	18
150232	Vijak za hrbtišče 4,0x25 beli cink	4,0	25	23
150201	Vijak za hrbtišče 4,0x30 beli cink	4,0	30	27
150236	Vijak za hrbtišče 4,0x35 beli cink	4,0	35	32
150400	Vijak za hrbtišče 4,0x40 beli cink	4,0	40	37
150401	Vijak za hrbtišče 4,5x40 beli cink	4,5	40	37
150238	Vijak za hrbtišče 5,0x40 beli cink	5,0	40	37
150402	Vijak za hrbtišče 5,0x50 beli cink	5,0	50	46
150338	Vijak za hrbtišče 5,0x60 beli cink	5,0	60	56

Vijak za hrbtišče

- ojačan, sintran s plastiko
- belo pocinkan
- posebno oblikovana glava za optimalno pritrditev
- zarez v glavi: križna zarez PZ2



FEX[®]-A

Vrtalni vijak za
Okenske okvirje

Prednosti

- vrtalna konica
- brez predvrtanja
- ugreznjena glava z rezkanimi rebri
- rezkana rebra olajšajo ugrez glave vijaka



Vrtalni vijak za okenske okvirje - FEX-A ugrezna glava, križna zarez PH

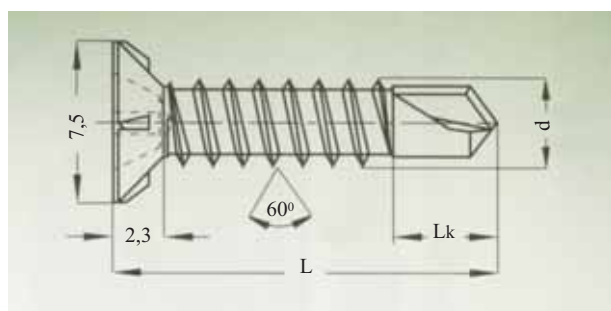

Šifra	Naziv	d (ø) mm	L mm	Lk mm
053915	Vijak vrtalni FEX-A vgrezni 3,9x16 bel	3,9	16	4,5
053918	Vijak vrtalni FEX-A vgrezni 3,9x19 bel	3,9	19	4,5
053924	Vijak vrtalni FEX-A vgrezni 3,9x25 bel	3,9	25	4,5
053931	Vijak vrtalni FEX-A vgrezni 3,9x32 bel	3,9	32	4,5
053937	Vijak vrtalni FEX-A vgrezni 3,9x38 bel	3,9	38	4,5

Vrtalni vijak za okenske okvirje - ugrezna glava

- za pritrjevanje enostenskih PVC profilov
- grob navoj s spodnjim žagasto nazobčanim robom
- pocinkan
- rezkalna rebra
- zaščita proti koroziji
- ravna ugrezna glava z rebri
- rebrasta glava spodaj omogoča lažje ugreznjenje vijaka
- vrtalna konica za optimalno moč vrtanja
- vrtalna konica za natančen začetek vrtanja in lažje predrtje materiala
- višina glave: 2,3 mm
- premer glave: \varnothing 7,5 mm
- dolžina vrtalne konice: 4,5 mm
- zarez v glavi: križna zarez PH2



**FEX[®]-KS**

Vijak za okovje
Za pritrnitev okovja na
PVC profile

Prednosti

- zavorna rebra
- samovrtna konica
- posebno globok navoj
- posneti spodnji del glave
- ni prekomernega privijanja



Vijak za okovje - FEX-KS ugrezna glava, križna zarez PH



Šifra	Naziv	d (ø) mm	L mm	hg mm
064016	Vijak vgrezni FEX-KS 4,0x16 beli cink	4,0	16	2,4
064021	Vijak vgrezni FEX-KS 4,0x20 beli cink	4,0	20	2,4
064026	Vijak vgrezni FEX-KS 4,0x25 beli cink	4,0	25	2,4
064031	Vijak vgrezni FEX-KS 4,0x30 beli cink	4,0	30	2,4
064036	Vijak vgrezni FEX-KS 4,0x35 beli cink	4,0	35	2,4
064041	Vijak vgrezni FEX-KS 4,0x40 beli cink	4,0	40	2,4
064046	Vijak vgrezni FEX-KS 4,0x45 beli cink	4,0	45	2,4

Vijak za pritrjevanje okovja na PVC profile

Glava

Posebna ugreznjena glava s posnetim spodnjim delom in zavornimi rebri pod glavo. S tem je zagotovljen jednat ugrez glave vijaka v površino okovja. Zavorna rebra dosežejo povečanje največjega vrtilnega momenta, kar poveča zaščito proti premočnim vijachenjem zlasti pri tankih PVC profilih.

Konica

Dolga, raztegnjena, ostra samovrtna konica s povečanim vrezovanjem navoja povzroči ugodno izdelavo tulke. Zato je zaščita proti premočnim vijachenjem večja, zlasti pri tankih PVC profilih brez ojačenja.

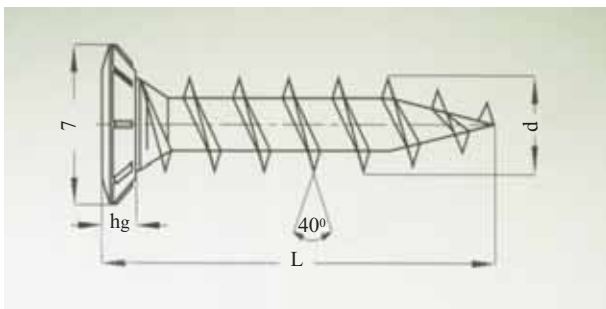

- zaščita proti koroziji ustreza na trgu priznanim okovjem za okna
- posebni globoki navoj do pod glave z velikim nagibom
- ugreznjena glava z zavornimi rebri
- vrtna konica za natančen začetek vijachenja
- premer glave: \varnothing 7,0 mm
- višina glave: h_g 2,4 mm
- zarez v glavi: križna zarez PH2

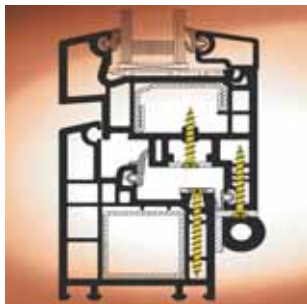



SPAX[®]-RA

Zidni vijak

S patentiranim valovitim profilom

Prednosti

- vijačenje okenskih in vratnih okvirjev brez PVC vložkov
- prihranek pri času
- univerzalna uporaba

**Dve
obliki glave**



Zidni vijak - SPAX-RA ugrezna glava T-STAR plus, Torx zarez

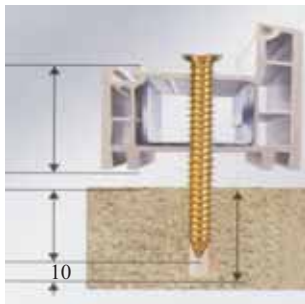
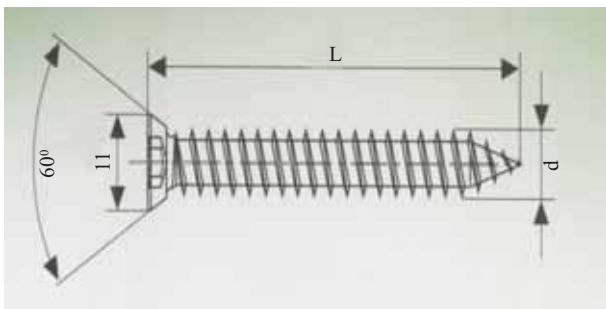

Šifra	Naziv	d (ø) mm	L mm
082318	Vijak zidni Spax 7,5x40 TX30 beli cink	7,5	40
082319	Vijak zidni Spax 7,5x60 TX30 beli cink	7,5	60
082320	Vijak zidni Spax 7,5x80 TX30 beli cink	7,5	80
082321	Vijak zidni Spax 7,5x100 TX30 beli cink	7,5	100
082322	Vijak zidni Spax 7,5x120 TX30 beli cink	7,5	120
082323	Vijak zidni Spax 7,5x150 TX30 beli cink	7,5	150
082324	Vijak zidni Spax 7,5x180 TX30 beli cink	7,5	180
082325	Vijak zidni Spax 7,5x210 TX30 beli cink	7,5	210

Zidni vijak

- ploščata ugreznjena glava T-STAR
- vijachenje okenskih in vratnih okvirjev brez PVC vložkov
- belo pocinkan
- univerzalna uporaba
- prihranek pri času
- dolžina vijaka je odvisna od:
 - debeline okvirja
 - razmika do zidu
 - globine vijachenja v zid
- vrtanje luknje: \varnothing 6,0 mm
- globina luknje: globina vijaka v zidu + 10 mm
- premer glave: \varnothing 11 mm
- zarez v glavi: Torx T30



Zidni vijak - SPAX-RA
ploščata bombirana glava T-STAR plus
Torx zareza



Šifra	Naziv	d (ø) mm	L mm
082311	Vijak zidni Spax 7,5x60 TX25 beli cink	7,5	60
082312	Vijak zidni Spax 7,5x80 TX25 beli cink	7,5	80
082313	Vijak zidni Spax 7,5x100 TX25 beli cink	7,5	100
082314	Vijak zidni Spax 7,5x120 TX25 beli cink	7,5	120
082315	Vijak zidni Spax 7,5x150 TX25 beli cink	7,5	150
082316	Vijak zidni Spax 7,5x180 TX25 beli cink	7,5	180
082317	Vijak zidni Spax 7,5x210 TX25 beli cink	7,5	210

Zidni vijak

- ploščata bombirana glava T-STAR
- vijačenje okenskih in vratnih okvirjev brez PVC vložkov
- belo pocinkan
- univerzalna uporaba
- prihranek pri času
- dolžina vijaka je odvisna od:
 - debeline okvirja
 - razmika do zidu
 - globine vijačenja v zid
- vrtanje luknje: \varnothing 6,0 mm
- globina luknje: globina vijaka v zidu + 10 mm
- premer glave: \varnothing 7,5 mm
- zarez v glavi: Torx T25

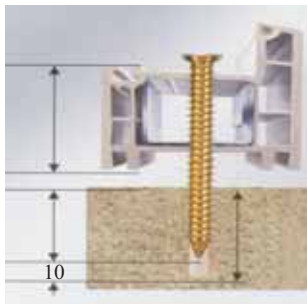
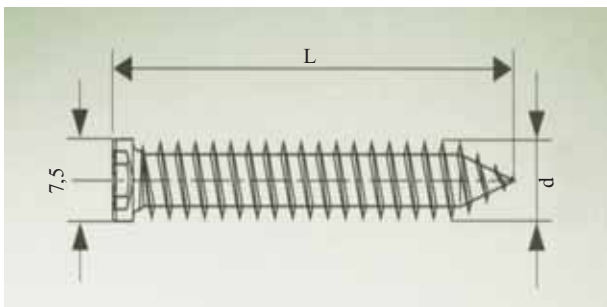

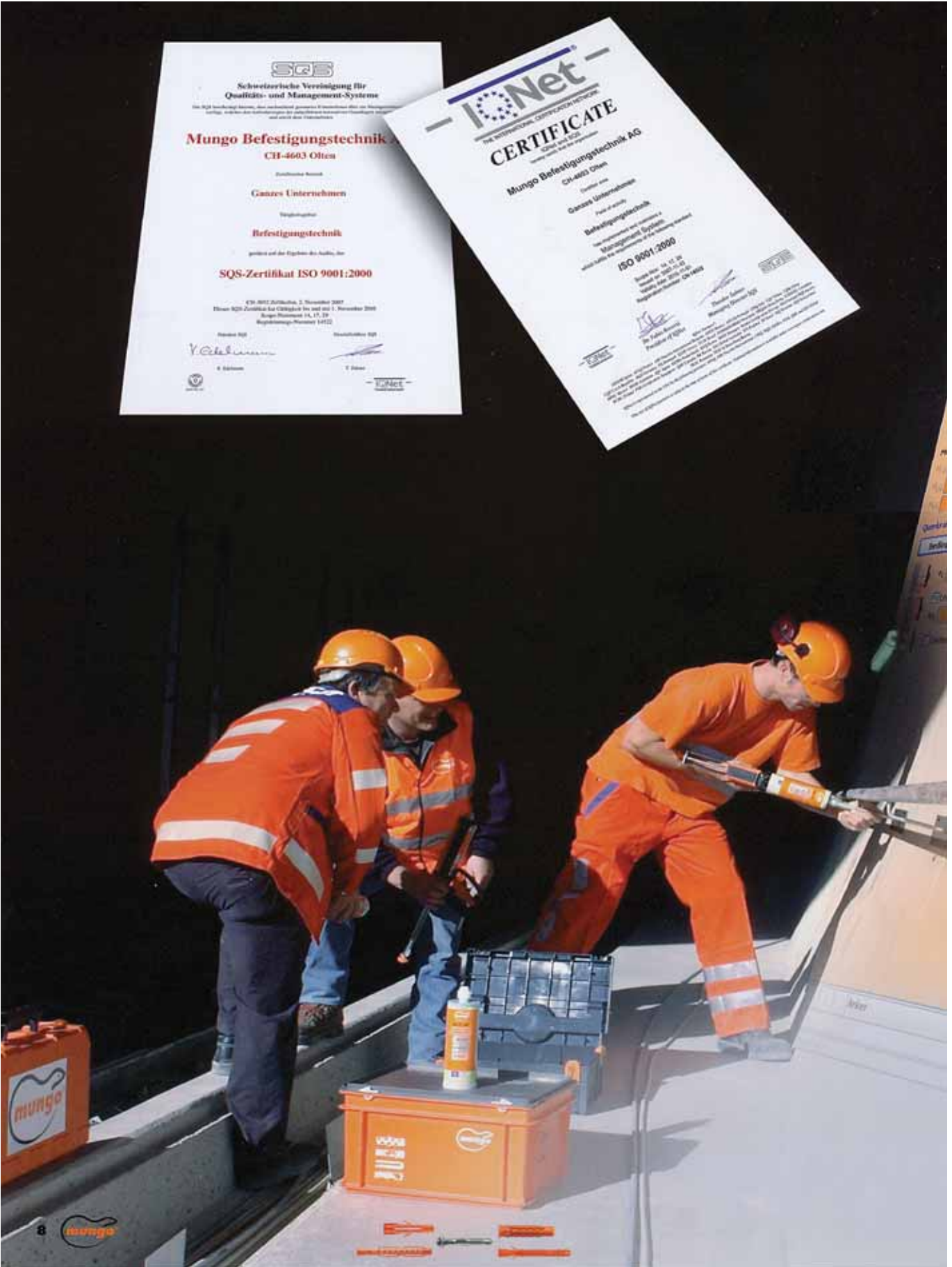



Nylonski vložek MN in kovček z vložki MN

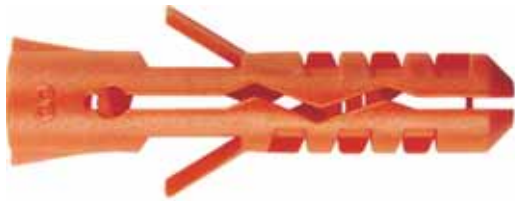

40 x 30 x 23,5 cm

Šifra	Naziv	Premer (ø) mm	Dolžina mm	Pakirano kos
082002	Vložek nylon MN 5x25-zidni	5,0	25	100
082003	Vložek nylon MN 6x30-zidni	6,0	30	100
082005	Vložek nylon MN 8x40-zidni	8,0	40	100
082006	Vložek nylon MN 10x50-zidni	10,0	50	50
082007	Vložek nylon MN 12x60-zidni	12,0	60	25
082008	Vložek nylon MN 14x70-zidni	14,0	70	20
082170	Kovček PVC z vložki MN 6x30 5600 kos.			5600
082171	Kovček PVC z vložki MN 8x40 2800 kos.			2800

Nylonski zidni vložek MN

- za uporabo z lesnimi vijaki, vijaki za vezane plošče in metričnimi vijaki
- uporaben je pri veliki večini gradbenih materialov
- izdelan iz zelo kakovostnega poliamida PA6
- čelna in skoznja montaža

Kovček z vložki MN

- material: PVC
- 6x30 mm: 5600 kos
- 8x40 mm: 2800 kos

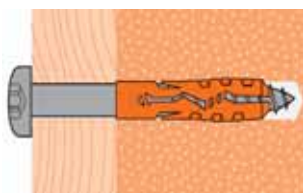
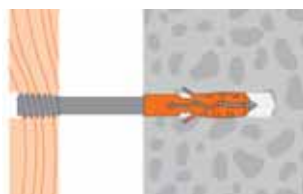
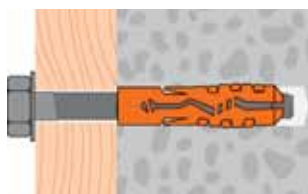

Zagibno varovalo

- preprečuje predčasen razcep zidnega vložka pri vgradnji



Središčna konica in bočni profil

- lažje vstavljanje v izvrtino
- zamaknjen bočni profil se globoko zarine v labilne gradbene materiale



Ozobje M

- zagotavlja pritiski tlak na celotni površini oboda ob sočasno dobrem stiku



Stabilizacijske točke

- povezava krakov zidnega vložka v obliki zadrge preprečuje prelome pri vstavljanju



Nylonski vložek MU in kovček z vložki MU

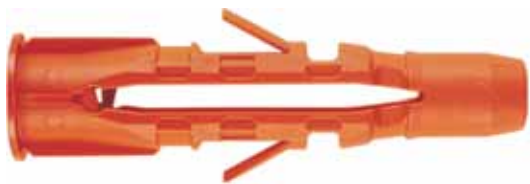

40 x 30 x 23,5 cm

Šifra	Naziv	Premer (ø) mm	Dolžina mm	Pakirano kos
082052	Vložek nylon MU 6x35-votlak	6	35	100
082054	Vložek nylon MU 8x50-votlak	8	50	50
082055	Vložek nylon MU 10x60-votlak	10	60	25
082056	Vložek nylon MU 12x70-votlak	12	70	20
082160	Kovček PVC z vložki MU 6x35 2800 kos.			2800
082161	Kovček PVC z vložki MU 8x50 1400 kos.			1400
082162	Kovček PVC z vložki MU 10x60 700 kos.			700

Nylonski zidni vložek MU

- za uporabo z lesnimi vijaki, vijaki za vezane plošče in metričnimi vijaki
- posebej primeren za votle prostore
- čelna in skožnja montaža
- izdelan iz zelo kakovostnega poliamida PA6
- naslon, ki se pri skožnji montaži samodejno odpre
- zagibno varovalo preprečuje predčasen razcep vložka pri vgradnji

Kovček z vložki MU

- material: PVC
- 6x35 mm: 2800 kos
- 8x50 mm: 1400 kos
- 10x60 mm: 700 kos

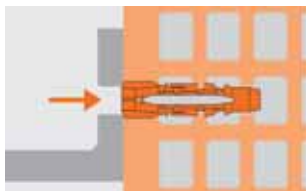

Zagibno varovalo

- preprečuje predčasen razcep zidnega vložka pri vgradnji

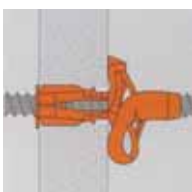
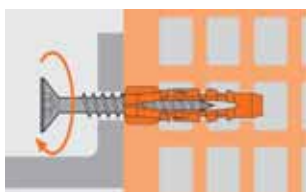

Multifunkcijska uporaba

- zanesljiva opora tudi v votlih prostorih zahvaljujoč vozlom

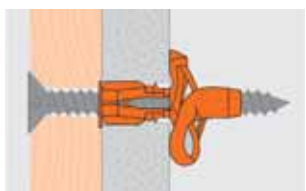

Čelna in skožnja montaža

- naslon, ki se pri skožnji montaži samodejno odpre omogoča multifunkcionalnost zidnega vložka

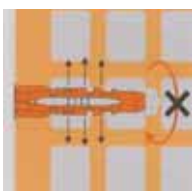

Prednapenjanje

- preprečuje sočasno vrtenje v vrtini



Nylonski zidni vložek MQ



Šifra	Naziv	Premer (ø) mm	Dolžina mm	Pakirano kos
082057	Vložek nylon MQ 6x30 mm-zidni	6,0	30	100
082058	Vložek nylon MQ 8x40 mm-zidni	8,0	40	100
082059	Vložek nylon MQ 10x50 mm-zidni	10,0	50	50

Nylonski zidni vložek MQ

- tehnologija Quattro
- primeren za večino gradbenih materialov
- posebej primeren za uporabo z vijaki za vezane plošče
- posebna geometrija zidnega vložka olajšuje vstavljanje v vrtino
- izdelan iz zelo kakovostnega poliamida PA6
- čelna montaža



Tehnologija Quattro

- najvišje možne sile oprijemanja v območju spodnje in srednje obremenitve
- posebej primeren za uporabo z vijaki za vezane plošče



Varovalo pred zasukom

- preprečuje sočasno vrtenje v vrtini



Skrajšan čas montaže

- posebna geometrija zidnega vložka olajšuje vstavljanje v vrtino

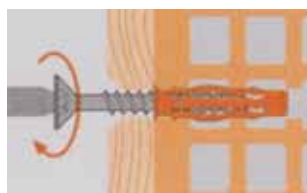

Zagibno varovalo

- preprečuje predčasen razcep zidnega vložka pri vgradnji





Nylonski fasadni zidni vložek MB



Šifra	Naziv	Premer (ø) mm	Dolžina mm	Pakirano kos
082150	Vložek nylon MB 10x120 mm	10,0	120	100
082151	Vložek nylon MB 10x140 mm	10,0	140	100
082152	Vložek nylon MB 10x160 mm	10,0	160	100
082153	Vložek nylon MB 10x200 mm	10,0	200	50

Nylonski fasadni zidni vložek za nestabilne gradbene materiale

- atestiran in posebej primeren za uporabo v porozni opeki in poroznem betonu
- MB s podaljšanim razcepnim delom za optimalno pritiskno silo v neobstojejih gradbenih materialih
- varovalo pred zasukom preprečuje sočasno vrtenje v izvrtini
- zagibno varovalo preprečuje predčasen razcep zidnega vložka pri vgradnji
- izdelan iz zelo kakovostnega poliamida PA6
- ø izvrtine v porozni betonu: 9 mm
- požarni preizkus F90
- skožnja montaža

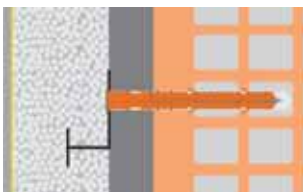
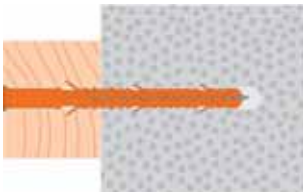

Atestiran

- posebej primeren za uporabo v porozni opeki in poroznem betonu



Varovalo pred zasukom

- preprečuje sočasno vrtenje v vrtini



Zagibno varovalo

- preprečuje predčasen razcep zidnega vložka pri vgradnji



Nylonski fasadni vložek MQL-SS z vijakom



Šifra	Naziv	Premer (ø) mm	Dolžina mm	Dolžina vijaka
082172	Vložek fasadni MQL-SS 10x80 + vijak	10	80	85
082173	Vložek fasadni MQL-SS 10x100 + vijak	10	100	105
082174	Vložek fasadni MQL-SS 10x120 + vijak	10	120	125
082175	Vložek fasadni MQL-SS 10x140 + vijak	10	140	145
082176	Vložek fasadni MQL-SS 10x160 + vijak	10	160	165
082177	Vložek fasadni MQL-SS 10x180 + vijak	10	180	185
082178	Vložek fasadni MQL-SS 10x200 + vijak	10	200	205

Nylonski fasadni vložek MQL-SS z vijakom

- za fasade, podstropne konstrukcije, profile, podkonstrukcije, fiksiranje izolacije
- povečana obremenitev zaradi možnosti raztezanja v 4 smeri
- globina fiksiranja 70 mm za povečano obremenitev
- ojačan vrat pri večjih dolžinah
- izdelan iz zelo kakovostnega poliamida PA6
- skozijska montaža
- premer vijaka: ø 7 mm
- glava vijaka: šestrobna M13
- požarni preizkus: F90

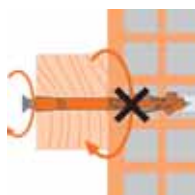
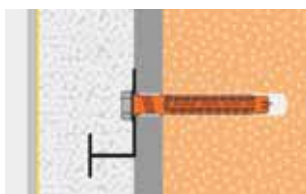

Trikratni upor

- proti vrtenju zidnega vložka prepreči njegovo rotacijo v izvrtani luknji, še posebej pri mehkih materialih



Blažilno področje

- omogoča prilagoditev razdalje na ravnih površinah



Zaščita proti zdrsu

- vijaka v vložek, kar preprečuje prehitro širitev vložka v steni



QUATTRO tehnologija

- omogoča, da se vložek v zidu razširi v 4 smeri, kar zagotavlja močnejše fiksiranje v zidu



Nylonski zidni vložek ML za porozne zidake



ML 6, ML 8



ML 10, ML 14

Šifra	Naziv	Premer (ø) mm	Dolžina mm	Pakirano kos
082070	Vložek Nylon ML 6x60 mm	6,0	60	100
082071	Vložek Nylon ML 8x80 mm	8,0	80	100
082073	Vložek Nylon ML 10x90 mm	10,0	90	100
082075	Vložek Nylon ML 14x90 mm	14,0	90	100

Nylonski zidni vložek ML za porozne zidake

- za uporabo z lesnimi vijaki, vijaki za vezane plošče in metričnimi vijaki
- posebna geometrija konice zidnega vložka pri ML6 in ML8 omogoča nastanek vozla pri uvijanju vijaka
- idealen za pritrditev v zidu
- varovalo zasuka preprečuje sočasno vrtenje v vrtini
- izdelan iz zelo kakovostnega poliamida PA6
- čelna in skožnja montaža

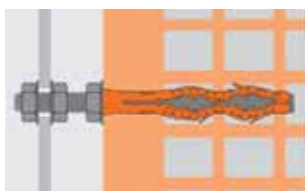
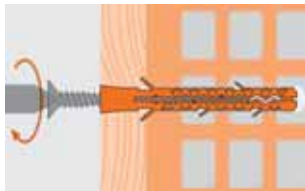
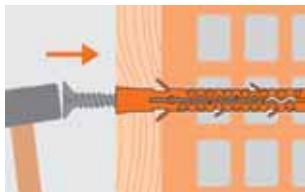



Nylonski vložek MNA-Z z žebbljem



Šifra	Naziv	Premer (ø) mm	Dolžina mm	Naslon (ø) mm
082100	Vložek pribitni MNA-Z 6x35 mm	6,0	35	12
082101	Vložek pribitni MNA-Z 6x50 mm	6,0	50	12
082102	Vložek pribitni MNA-Z 6x60 mm	6,0	60	12
082103	Vložek pribitni MNA-Z 6x70 mm	6,0	70	12
082104	Vložek pribitni MNA-Z 8x60 mm	8,0	60	15
082105	Vložek pribitni MNA-Z 8x80 mm	8,0	80	15
082106	Vložek pribitni MNA-Z 8x100 mm	8,0	100	15
082107	Vložek pribitni MNA-Z 8x120 mm	8,0	120	15
082108	Vložek pribitni MNA-Z 8x140 mm	8,0	140	15

Nylonski vložek MNA-Z z žebbljem

- vložek z žebbljem za hitro montažo - zabijanje s kladivom
- navoj žeblja v obliki zob pile
- ojačana glava žeblja
- podaljšana razcepna cona vložka
- nerjaveča izvedba za zunanjo uporabo
- izdelan iz zelo kakovostnega poliamida PA 6
- skožnja montaža
- enostavna demontaža z odvijanjem
- zareza na glavi žeblja:
MNA-Z 6 mm: PZ 2
MNA-Z 8 mm: PZ 3
- pakirano: 100 kos

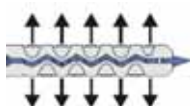
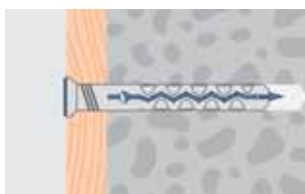
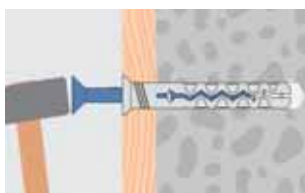
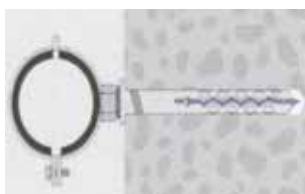
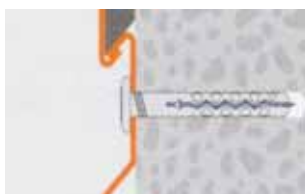

Območje razcepa

- podaljšana cona razcepa zagotavlja optimalne parametre nosilnosti



Ojačana glava žeblja

- vzdrži močne udarce in povečuje pritiskno silo na območju grla zidnega vložka

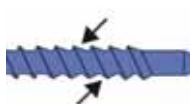

Žagast navoj žeblja

- omogoča naknadno nastavitvev ali demontažo



Cilindrična oblika naslona



Nylonski vložek MWC z vijakom in pokrivno kapico



Šifra	Naziv	Premer (ø) mm	Dolžina mm	Pakirano kpl
082130	Vložek z vijakom MWCc 8x40 mm	8,0	40	1

Nylonski vložek MWC z vijakom in pokrivno kapico

- za pritrditev WC-ja in bideja
- primeren za večino gradbenih materialov
- izdelan iz zelo kakovostnega poliamida PA6
- čelna montaža
- **komplet vsebuje:**
 - 2 x vložek MQ 8x40 mm
 - 2 x vijak s šestrobno glavo ø 6x70 mm
 - 2 x rozeta
 - 2 x kromirana pokrivna kapica

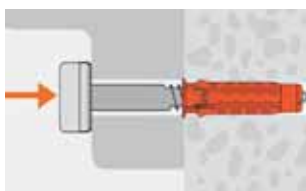
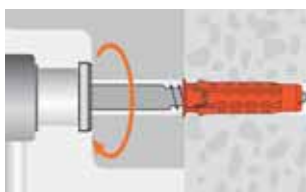
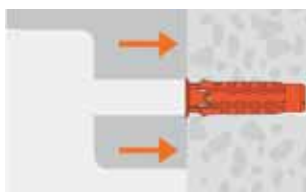



Vložek MFJ-32 in kovček z vložki MFJ-32



40 x 30 x 23,5 cm

Šifra	Naziv	Premer (ø) mm	Dolžina mm	Pakirano kos
082361	Vložek vijalni MFJ 14x32 mm Mungo	14	32	100
082164	Kovček PVC z vložki MFJ32 14x32 2800			2800
082362	Nastavek za vijalni vložek Mungo			

Vložek MFJ 32

- za enojne plošče
- material: Fiber Jet plastika ojačana s steklenimi vlakni
- električno izoliran
- za montažo električnih stikal, luči, slik
- čelna montaža

Kovček z vložki MFJ32

- material: PVC
- 14x32 mm: 2800 kos



Nastavek Duo-bit za vijalni vložek MFJ in MJP

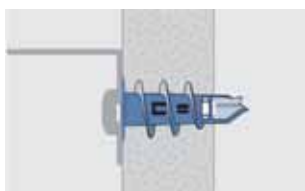
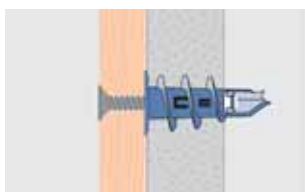
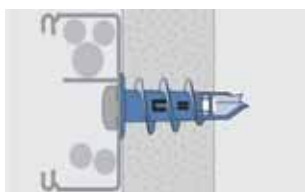



Vijačni vložek MJP in nastavek Duo-bit

Šifra	Naziv	Premer (ø) mm	Dolžina mm	Pakirano kos
082360	Vložek vijačni MJP 14x39 Mungo	14	39	100



Vijačni vložek MJP

- za enojne in dvojne mavčno-kartonske plošče/plošče iz mavčnih vlaken
- material: kovina Jet Plug
- čelna montaža
- za montažo luči, slik, letev, talnih letev, majhnih stenskih regalov



Nastavek Duo-bit za vijačni vložek MFJ in MJP

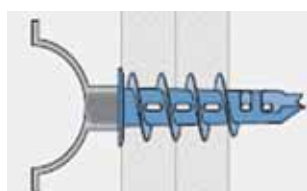
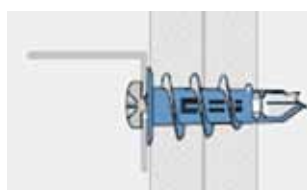
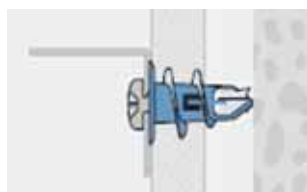

Metrični priključni navoj

- priključni navoj za učinkovito montažo gradbenih elementov-cevnihih objemk



Vitek rezalni navoj

- omogoča dobro vrezovanje v mehke gradbene materiale



Varovalo povratnega vrtenja

- omogoča odvijanje vijaka ne da bi se sočasno vrtel tudi zidni vložek



Centrirna konica

- zagotavlja preprosto nastavitvev in zavrtanje v ploščo



Kovinski vložek za votle prostore MHD-S



Šifra	Naziv	Vrtina (ø) mm	Dolžina mm
082365	Vložek alu. z vijakom MHDS M4x32 (3/13) Mungo	8,0	41
082367	Vložek alu. z vijakom MHDS M4x46 (16/24) Mungo	8,0	54
082370	Vložek alu. z vijakom MHDS M5x52 (5/21) Mungo	10,0	60
082371	Vložek alu. z vijakom MHDS M5x65 (5/34) Mungo	10,0	74
082374	Vložek alu. z vijakom MHDS M6x52 (5/21) Mungo	12,0	60
082375	Vložek alu. z vijakom MHDS M6x65 (16/34) Mungo	12,0	74
082376	Vložek alu. z vijakom MHDS M8x65 (16/34) Mungo	13,0	75
082377	Vložek alu. z vijakom MHDS M8x80(32/50) Mungo	13,0	90

Kovinski vložek za votle prostore MHD-S

- vijak je že vstavljen v vložek
- kontrolirana, enostavna in hitra montaža z montažnimi kleščami
- povečana nosilnost in zanesljivost montaže
- vijak M4, M5, M6: glava s križno zarezo
- vijak M8: šestrobna glava na ključ
- spoj je tesen z osnovnim materialom
- za ploščate stene in votle materiale
- skožnja montaža
- pakirano: 100 kos

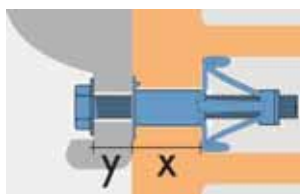
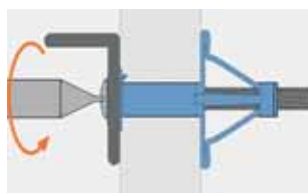
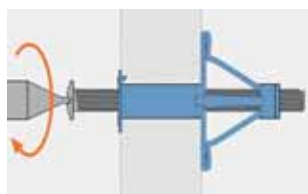
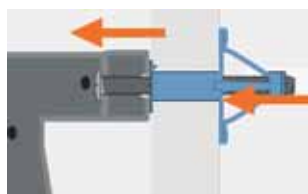
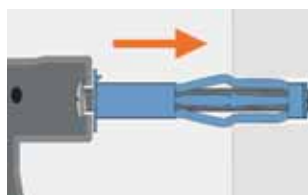

Vložek	Y max mm	X mm
M4x32	16	3-13
M4x46	16	16-24
M5x52	24	5-21
M5x65	16	16-34
M6x52	24	5-21
M6x65	26	16-34
M8x65	25	16-34
M8x80	30	32-50



Kovček z vložki MHD-S



40 x 30 x 10 cm



Kovinski vložek MHD-S z vijakom

Šifra	Naziv	Dolžina cm	Širina cm	Višina cm
082163	Kovček z vložki MHD-S	40	30	10

Kovček z vložki MHD-S

- material: PVC

- vsebina kovčka:

Ojačane montažne klešče M4-M6

Vložki MHD-S z vijakom:

M4x25 mm: 50 kos

M4x41 mm: 50 kos

M4x54 mm: 50 kos

M5x60 mm: 25 kos

M5x74 mm: 25 kos

M6x60 mm: 25 kos

M6x88 mm: 25 kos



Ojačane montažne klešče M4-M6

Montažne klešče za vložke MHD-S



M4-M6



M4-M8

Šifra	Naziv
082378	Klešče za al. vložek MHDS M4-M6
082379	Klešče za al. vložek MHDS M4-M8

Montažne klešče za vložke MHD-S

- hitra in enostavna montaža vložkov MHD-S



Jekleni vložek MSS-B z vijakom



Šifra	Naziv	Premer (ø) mm	Vijak	Dolžina navoja
082080	Vložek kov. z vijakom MSS-B M6x65	12,0	M6	65
082081	Vložek kov. z vijakom MSS-B M8x90	14,0	M8	90
082082	Vložek kov. z vijakom MSS-B M10x105	16,0	M10	105
082083	Vložek kov. z vijakom MSS-B M12x125	20,0	M12	125

Jekleni razcepni zidni vložek MSS-B z vijakom

- za velike obremenitve
- nadzorovana sila in navor razcepa
- galvansko pocinkanje > 5 µm
- čelna in skožnja montaža
- za cevne napeljave, jeklene konstrukcije, podkonstrukcije, stroji, ...

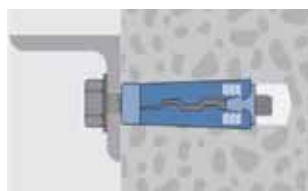
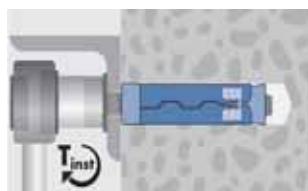
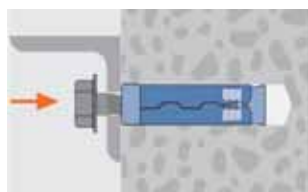
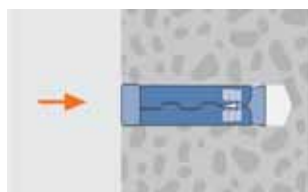
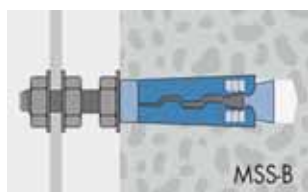



Kovinski vložek MMS z vijakom



Šifra	Naziv	Premer (ø) mm	Dolžina mm	Koristna dolžina
082386	Vložek kovinski MMS 8x70 mm	8,0	70	40
082390	Vložek kovinski MMS 10x70 mm	10,0	70	30
082395	Vložek kovinski MMS 10x90 mm	10,0	90	50
082391	Vložek kovinski MMS 10x110 mm	10,0	110	70
082392	Vložek kovinski MMS 10x130 mm	10,0	130	90
082394	Vložek kovinski MMS 10x150 mm	10,0	150	110

Kovinski vložek MMS z vijakom

- za kovinske okvirje
- razširitveni konus je zavarovan pred zasukom in izpadanjem
- uporaba v trdnih gradbenih materialih
- galvansko pocinkan > 5 µm
- skožnja montaža
- zareza v glavi:
MMS 8: križna PZ2
MMS 10: križna PZ3

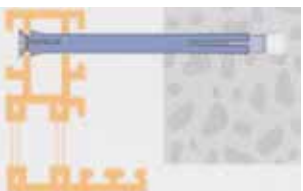
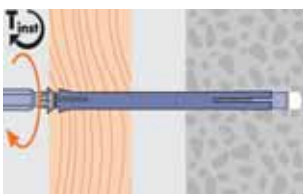
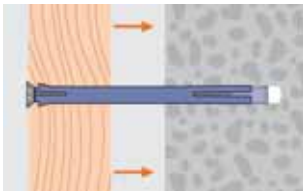
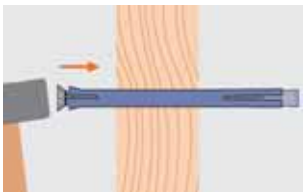



Zagozdno sidro MAN



Šifra	Naziv	Premer (ø) mm	Dolžina mm	Pakirano kos
082444	MAN Sidro zagozdno M6x40 mm	6,0	40	100
082445	MAN Sidro zagozdno M6x70 mm	6,0	70	100

Zagozdno sidro MAN

- za sidranje raznih profilov
- atestiran za večkratno pritrjevanje za sidranje lahkih stropnih opažev in spušenih stropov v skladu z DIN 18168
- požarni preizkus F30-F120
- enostavna montaža z natančnim zabijanjem štrlečega čepa
- galvansko pocinkan > 5 µm
- skožnja montaža
- pri uporabi spušenih stropov, podkonstrukcijah, profilih

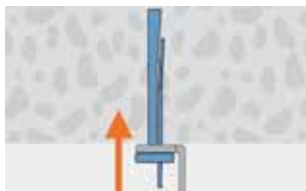

Glava zagozdnega sidra

- nalega preko velike površine in zagotavlja gladko prekrivanje



Kovinski vložek MIGH



Šifra	Naziv	Vrtina (ø) mm	Dolžina mm	Navoj
082433	MIGH M6 12x48 mm kovinski vložek	10,0	48	M6
082434	MIGH M8 16x80 mm kovinski vložek	14,0	80	M8

Kovinski vložek MIGH

- vložek omogoča manjšo porabo kita in natančnejše pozicioniranje vijaka, navojne palice
- prihranek časa in denarja pri porabi kita
- notranji metrični navoj

Mrežasti PVC vložek MSH



Šifra	Naziv	Premer (ø) mm	Dolžina mm	Vijak mm
082425	MSH 12/9x50 Vložek PVC MIT	9,0	50	M6-M8
082426	MSH 16/13x85 Vložek PVC MIT	13,0	85	M8-M12

Mrežasti PVC vložek MSH

- vložek omogoča manjšo porabo kita in natančnejše pozicioniranje vijaka, navojne palice
- prihranek časa in denarja pri porabi kita

Mrežasti kovinski vložek



Šifra	Naziv	Premer (ø) mm	Dolžina mm	Vijak
082427	MSM 12 Vložek kovinski 11x1000 mm	11,0	1000	≤ 8
082428	MSM 16 Vložek kovinski 15x1000 mm	15,0	1000	≤ 16

Mrežasti kovinski vložek

- vložek omogoča manjšo porabo kita in natančnejše pozicioniranje vijaka, navojne palice
- prihranek časa in denarja pri porabi kita
- vložek enostavno odrežemo na želeno dolžino
- dolžina: 100 cm

Kotni vijak



Šifra	Naziv	Premer (ø) mm	Dolžina mm	Pakirano kos
082600	SR-L Vijak kotnik M4x38 cink	4,0	38	100
082601	SR-L Vijak kotnik M5x45 cink	5,0	45	100
082602	SR-L Vijak kotnik M5x58 cink	5,0	58	100
082603	SR-L Vijak kotnik M6x40 cink	6,0	40	100
082604	SR-L Vijak kotnik M6x60 cink	6,0	60	100

Kotni vijak

- pocinkan
- metrični navoj



Vzmetni vložek MF-M in MF-H



z navojem

s kljukico

Šifra	Naziv	Premer (ø) mm	Dolžina mm	Pakirano kos
082440	MF-M Vložek vzmetni z navojem M4	4,0	90	50
082441	MF-M Vložek vzmetni z navojem M5	5,0	100	25
082442	MF-H Vložek vzmetni s kljukico M4	4,0	70	50
082443	MF-H Vložek vzmetni s kljukico M5	5,0	70	25

Vzmetni vložek MF-M in MF-H

- vložek potisnemo v luknjo, roki stisnemo skupaj
- ko vložek pride skozi ploščo (strop, steno ...), vzmet razpne roki
- s podložko in matico fiksiramo vzmetni vložek
- hitra in preprosta montaža
- majhna globina praznega prostora
- skozijska montaža
- uporaba pri spuščениh stropih, ...
- odprtina:
M4: ø 14 mm
M5: ø 16 mm

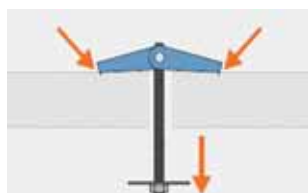



Nylonski zidni vložek F



Šifra	Naziv	Premer (ø) mm	Dolžina mm	Pakirano kos
101400	MEA Vložek nylon F 5x25-zidni	5,0	25	100
101401	MEA Vložek nylon F 6x30-zidni	6,0	30	100
101403	MEA Vložek nylon F 8x40-zidni	8,0	40	100
101404	MEA Vložek nylon F 10x50-zidni 0,5c	10,0	50	50
101405	MEA Vložek nylon F 12x60-zidni 0,25c	12,0	60	25
101406	MEA Vložek nylon F 14x70-zidni 0,2c	14,0	70	20

Nylonski zidni vložek F

- material: nylon
- visoka natezna moč
- visoka trdnost pri zabijanju
- visoka odpornost proti puljenju
- temperaturna obstojnost: -40 °C do +80 °C
- skožnja in čelna montaža
- uporaben za materiale: beton, naravni kamen, polna opeka, polna opeka iz apnenega peščenca, opeka iz plovca





Nylonski vložek FL



FL 6



FL 8, 10

Šifra	Naziv	Premer (ø) mm	Dolžina mm	Pakirano kos
101414	MEA Vložek nylon FL 6x60-podaljšani	6,0	60	100
101415	MEA Vložek nylon FL 8x80-pod. 0,5c	8,0	80	50
101416	MEA Vložek nylon FL 10x90-pod. 0,25c	10,0	90	25

Nylonski vložek FL

- material: nylon
- podaljšan standardni vložek
- podaljšano območje razcepa
- idealen za polne in votle materiale s porami (npr. stare zgradbe)
- krila preprečujejo vrtenje vložka v izvrtini
- čelna in skožnja montaža
- uporaben za materiale: beton, polna opeka, votla opeka, luknjičasta opeka iz apnenega peščenca, ...

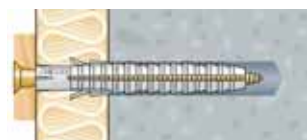

Nylonski vložek FX



Šifra	Naziv	Premer (ø) mm	Dolžina mm	Pakirano kos
101409	MEA Vložek nylon FX 5x25 rob-zidni	5,0	25	100
101410	MEA Vložek nylon FX 6x30 rob-zidni	6,0	30	100
101411	MEA Vložek nylon FX 8x40 rob-zidni	8,0	40	100
101412	MEA Vložek nylon FX 10x50 rob-zidni	10,0	50	50

Nylonski vložek FX

- material: nylon
- uporaben za večino gradbenih materialov
- raztezanje v 4 smeri
- uporaba z različnimi vijaki
- oblika glave preprečuje, da bi vložek zlezel v izvrtino
- rebra omogočajo čvrst oprijem
- močan





Vložek MZ in MKZ za votle matariale



MZ



MKZ

Šifra	Naziv	Premer (ø) mm	Dolžina mm	Pakirano kos
101417	MEA Vložek MZ 6x40-votlak	6,0	40	100
101418	MEA Vložek MZ 8x48-votlak	8,0	48	100
101419	MEA Vložek MZ 10x59-votlak 0,5c	10,0	59	50
101420	MEA Vložek MZ 12x71-votlak 0,5c	12,0	71	50
101477	MEA Vložek MKZ 6x41PVC pak-vot. 2c	6,0	41	200
101422	MEA Vložek MKZ 6x41 rob-votlak	6,0	41	100
101423	MEA Vložek MKZ 8x49 rob-votlak	8,0	49	100
101478	MEA Vložek MKZ 8x49 PVC pak-v. 0,9c	8,0	49	90
101424	MEA Vložek MKZ 10x60 rob-votlak 0,5c	10,0	60	50
101479	MEA Vložek MKZ 10x60 PVC pak. 0,5c	10,0	60	50
101425	MEA Vložek MKZ 12x72 rob-votlak 0,5c	12,0	72	50

Vložek MZ in MKZ za votle matariale

- vložek MZ za skoznjo montažo
- vložek MKZ z robom, ki preprečuje, da bi vložek zlezel v izvrtino
- uporaben za materiale: beton, naravni kamen, votla opeka, polna opeka, polna opeka iz apnenega peščenca, luknjičasta opeka iz apnenega peščenca, opeka iz plovca, lahka votla opeka, mavčne plošče, plošče iz stisnjenih vlaken, iverne plošče, siporex,
- uporaba z lesnimi vijaki, vijaki za iverne plošče
- material: zelo kakovosten polyetilen

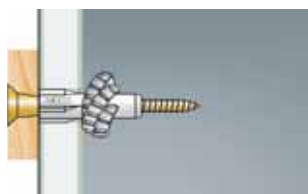

Pakiranje



Pakiranje v PVC embalaži

- šifra:
- 101477
- 101478
- 101479



Vložek BOB-SP



Šifra	Naziv	Premer (ø) mm	Dolžina mm	Pakirano kos
101470	MEA Vložek BOB SP 6x29-zidni	6,0	29	100
101471	MEA Vložek BOB SP 8x36-zidni	8,0	36	100
101472	MEA Vložek BOB SP 10x48-zidni 0,5 cent	10,0	48	50

Vložek BOB-SP

- krila preprečujejo vrtenje
- za manj zahtevno uporabo

Vložek BOB-UP za votle stene



Šifra	Naziv	Premer (ø) mm	Dolžina mm	Pakirano kos
101473	Mea vložek BOB UP 6x39 mm-votlak	6,0	39	100
101474	Mea vložek BOB UP 8x50 mm-votlak	8,0	50	100
101475	Mea vložek BOB UP 10x60 mm-votlak	10,0	60	50

Vložek BOB-UP za votle stene

- rebra preprečujejo vrtenje
- za manj zahtevno uporabo

Nylonski vložek NP z žebljem



Šifra	Naziv	Premer (ø) mm	Dolžina mm	Pakirano kos
101445	MEA Vložek NP 6x35 pribitni	6	35	100
101446	MEA Vložek NP 6x40 pribitni	6	40	100
101447	MEA Vložek NP 6x50 pribitni 0,5c	6	50	50
101448	MEA Vložek NP 6x60 pribitni 0,5c	6	60	50
101449	MEA Vložek NP 6x70 pribitni 0,5c	6	70	50
101451	MEA Vložek NP 8x60 pribitni 0,5c	8	60	50
101452	MEA Vložek NP 8x80 pribitni 0,5c	8	80	50
101453	MEA Vložek NP 8x100 pribitni 0,5c	8	100	50
101454	MEA Vložek NP 8x120 pribitni 0,5c	8	120	50

Nylonski vložek NP z žebljem

- material: nylon
- vložek z žebljem za hitro montažo
- zabijanje s kladivom
- navoj žeblja v obliki zob pile
- skožnja montaža
- enostavna demontaža z odvijačjem
- zareza v glavi: križna PZ
- uporaben za materiale: beton, polna opeka, polna opeka iz apnenega peščenca, luknjičasta opeka iz apnenega peščenca, opeka iz plovca, votla opeka, naravni kamen, siporex
- ojačana glava vložka preprečuje, da žebelj zleze v vložek
- material: nylon

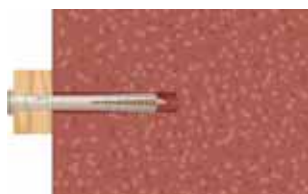



Nylonski vložek HR za mavčne plošče



Šifra	Naziv	Premer (ø) mm	Dolžina mm	d mm
101456	MEA Vložek za gips Nylon HR 6x30	6,0	30	3-14
101457	MEA Vložek za gips Nylon HR 8x40 0,5c	8,0	40	10-16

Nylonski vložek HR za mavčne plošče

- material: nylon
- uporaba: votli stropi, votle stene, mavčne plošče, iverne plošče
- uporaben za materiale: mavčne plošče, iverke
- uporaben z lesnimi vijaki
- pakirano:
HR 6x30: 100 kos
HR 8x40: 50 kos

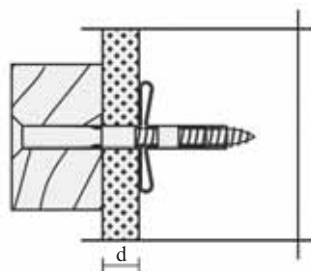
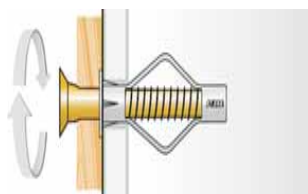

Kovinski vložek HRM za votle prostore

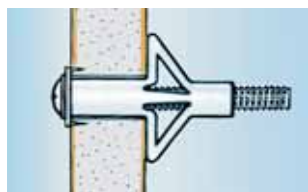
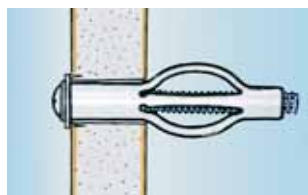
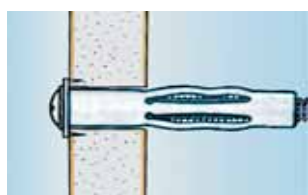

Šifra	Naziv	Premer (ø) mm	Dolžina mm	d mm
101459	MEA Vložek za gips kov. HRM 4/20x46	8,0	46	3-20
101460	MEA Vložek za gips kov. HRM 4/38x59	8,0	59	32-38
101461	MEA Vložek za gips kov. HRM 5/16x52	11,0	52	13-16
101462	MEA Vložek za gips kov. HRM 5/32x65	11,0	65	14-32
101463	MEA Vložek za gips kov. HRM 6/16x52	13,0	52	13-16
101464	MEA Vložek za gips kov. HRM 6/32x65	13,0	65	14-32

Kovinski vložek HRM za votle prostore

- uporaba: votli stropi, votle stene, mavčne plošče, iverne plošče, ploščate stene
- vijak je že vstavljen v vložek
- debelina stene: 3-38 mm (odvisno od vložka - glej tabelo)
- povečana nosilnost in zanesljivost montaže
- spoj je tesen z osnovnim materialom
- skožnja montaža
- material: kovina
- obdelava: belo cinkano
- hitra montaža z montažnimi kleščami
- pakirano: 100 kos

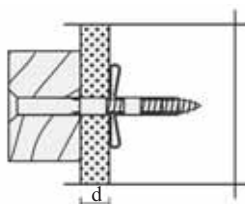

Montažne klešče za HRM vložke



Šifra	Naziv
101465	MEA Klešče za HRM vložke

Montažne klešče za HRM vložke

- hitra in enostavna montaža HRM vložkov



Vložek GKD za mavčne plošče



Šifra	Naziv	Premer (ø) mm	Dolžina mm	Pakirano kos
101428	MEA Vložek za gips GKD PVC-polž 0,5c	14	33	50

Vložek GKD za mavčne plošče

- uporaba: mavčne plošče
- uporaben z vijaki za les, vijaki za iverne plošče, vijaki M4
- material: PVC

Kovinski vložek GKDZ za mavčne plošče

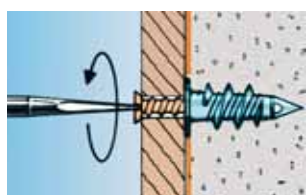
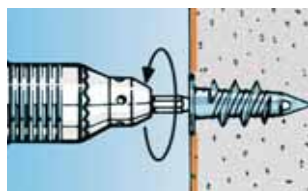

Šifra	Naziv	Premer (ø) mm	Dolžina mm	Pakirano kos
101427	MEA Vložek za gips GKDZ kovinski-polž	14	28	100

Kovinski vložek GKDZ za mavčne plošče

- uporaba: mavčne plošče
- uporaben z vijaki za les, vijaki za iverne plošče, vijaki M4
- kovinski



Nylonski vložek GB za siporex



Šifra	Naziv	Premer (ø) mm	Dolžina mm	Pakirano kos
101429	MEA Vložek Nylon GB 10x55-siporex 0,25	10	55	25
101430	MEA Vložek Nylon GB 12x60-siporex 0,2c	12	60	20

Nylonski vložek GB za siporex

- material: nylon
- uporaba: mavčne stene, siporex
- uporaben z lesnimi vijaki
- v siporex AAC4 zvrtno majhno luknjo za oba vložka
- v siporex AAC2 lahko vložek GB 10x55 zabijemo brez vrtnja
- material: nylon

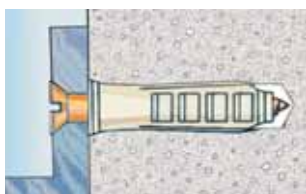
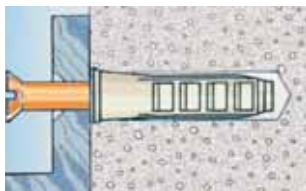
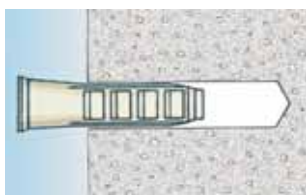

STARMAN

Stojalni vijak s šestrobno glavo

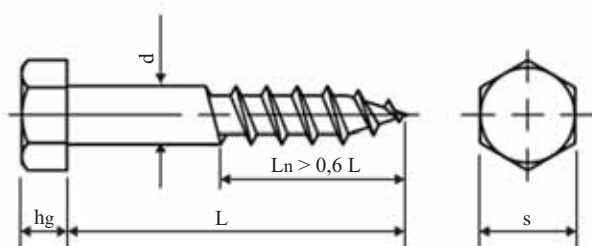

Šifra	Naziv	d (ø) mm	L mm	s	hg mm
151281	Vijak stojalni 5x20 DIN571	5,0	20	M8	3,5
151282	Vijak stojalni 5x25 DIN571	5,0	25	M8	3,5
151283	Vijak stojalni 5x30 DIN571	5,0	30	M8	3,5
151284	Vijak stojalni 5x35 DIN571	5,0	35	M8	3,5
151270	Vijak stojalni 5x40 DIN571	5,0	40	M8	3,5
151285	Vijak stojalni 5x45 DIN571	5,0	45	M8	3,5
151268	Vijak stojalni 5x50 DIN571	5,0	50	M8	3,5
151286	Vijak stojalni 5x60 DIN571	5,0	60	M8	3,5
151287	Vijak stojalni 5x70 DIN571	5,0	70	M8	3,5
151288	Vijak stojalni 5x80 DIN571	5,0	80	M8	3,5
151289	Vijak stojalni 6x20 DIN571	6,0	20	M10	4,0
150821	Vijak stojalni 6x25 DIN571	6,0	25	M10	4,0
150731	Vijak stojalni 6x30 DIN571	6,0	30	M10	4,0
150733	Vijak stojalni 6x35 DIN571	6,0	35	M10	4,0
151250	Vijak stojalni 6x40 DIN571	6,0	40	M10	4,0
151249	Vijak stojalni 6x45 DIN571	6,0	45	M10	4,0
151251	Vijak stojalni 6x50 DIN571	6,0	50	M10	4,0
151290	Vijak stojalni 6x55 DIN571	6,0	55	M10	4,0
150240	Vijak stojalni 6x60 DIN571	6,0	60	M10	4,0
151291	Vijak stojalni 6x65 DIN571	6,0	65	M10	4,0
150253	Vijak stojalni 6x70 DIN571	6,0	70	M10	4,0
150251	Vijak stojalni 6x80 DIN571	6,0	80	M10	4,0
150255	Vijak stojalni 6x90 DIN571	6,0	90	M10	4,0
150728	Vijak stojalni 6x100 DIN571	6,0	100	M10	4,0
150729	Vijak stojalni 6x110 DIN571	6,0	110	M10	4,0
151252	Vijak stojalni 6x120 DIN571	6,0	120	M10	4,0
151269	Vijak stojalni 6x130 DIN571	6,0	130	M10	4,0
151265	Vijak stojalni 6x140 DIN571	6,0	140	M10	4,0
151292	Vijak stojalni 6x150 DIN571	6,0	150	M10	4,0
151276	Vijak stojalni 6x160 DIN571	6,0	160	M10	4,0
151293	Vijak stojalni 6x180 DIN571	6,0	180	M10	4,0
151294	Vijak stojalni 6x200 DIN571	6,0	200	M10	4,0
151295	Vijak stojalni 6x210 DIN571	6,0	210	M10	4,0

Stojalni vijak s šestrobno glavo

- material: jeklo
- lesni navoj
- obdelava: belo cinkano
- narejen po standardu DIN571

STARMAN

Stojalni vijak s šestrobno glavo

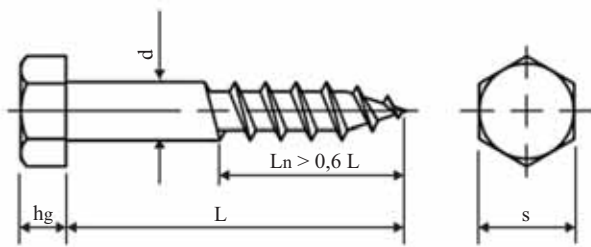

Šifra	Naziv	d (ø) mm	L mm	s	hg mm
151296	Vijak stojalni 8x25 DIN571	8,0	25	M13	5,5
151274	Vijak stojalni 8x30 DIN571	8,0	30	M13	5,5
150735	Vijak stojalni 8x35 DIN571	8,0	35	M13	5,5
151267	Vijak stojalni 8x40 DIN571	8,0	40	M13	5,5
151297	Vijak stojalni 8x45 DIN571	8,0	45	M13	5,5
150734	Vijak stojalni 8x50 DIN571	8,0	50	M13	5,5
150241	Vijak stojalni 8x60 DIN571	8,0	60	M13	5,5
150737	Vijak stojalni 8x70 DIN571	8,0	70	M13	5,5
150242	Vijak stojalni 8x80 DIN571	8,0	80	M13	5,5
151255	Vijak stojalni 8x90 DIN571	8,0	90	M13	5,5
151253	Vijak stojalni 8x100 DIN571	8,0	100	M13	5,5
150738	Vijak stojalni 8x110 DIN571	8,0	110	M13	5,5
151254	Vijak stojalni 8x120 DIN571	8,0	120	M13	5,5
151298	Vijak stojalni 8x130 DIN571	8,0	130	M13	5,5
151258	Vijak stojalni 8x140 DIN571	8,0	140	M13	5,5
151263	Vijak stojalni 8x150 DIN571	8,0	150	M13	5,5
151264	Vijak stojalni 8x160 DIN571	8,0	160	M13	5,5
151299	Vijak stojalni 8x170 DIN571	8,0	170	M13	5,5
151277	Vijak stojalni 8x180 DIN571	8,0	180	M13	5,5
151266	Vijak stojalni 8x200 DIN571	8,0	200	M13	5,5
151300	Vijak stojalni 8x220 DIN571	8,0	220	M13	5,5
151304	Vijak stojalni 8x240 DIN571	8,0	240	M13	5,5
151344	Vijak stojalni 8x250 DIN571	8,0	250	M13	5,5
151345	Vijak stojalni 8x260 DIN571	8,0	260	M13	5,5
151346	Vijak stojalni 8x280 DIN571	8,0	280	M13	5,5
151347	Vijak stojalni 8x300 DIN571	8,0	300	M13	5,5

Stojalni vijak s šestrobno glavo

- material: jeklo
- lesni navoj
- obdelava: belo cinkano
- narejen po standardu DIN571

STARMAN

Stojalni vijak s šestrobno glavno

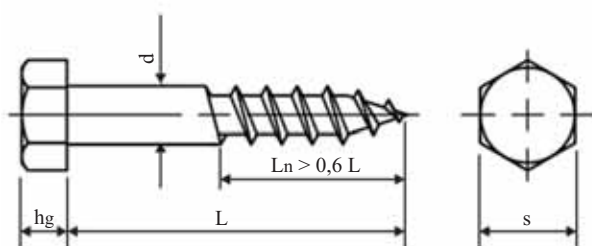

Šifra	Naziv	d (ø) mm	L mm	s	hg mm
151348	Vijak stojalni 10x30 DIN571	10,0	30	M17	7,0
151349	Vijak stojalni 10x35 DIN571	10,0	35	M17	7,0
151360	Vijak stojalni 10x40 DIN571	10,0	40	M17	7,0
151361	Vijak stojalni 10x45 DIN571	10,0	45	M17	7,0
151362	Vijak stojalni 10x50 DIN571	10,0	50	M17	7,0
151363	Vijak stojalni 10x55 DIN571	10,0	55	M17	7,0
150809	Vijak stojalni 10x60 DIN571	10,0	60	M17	7,0
150890	Vijak stojalni 10x65 DIN571	10,0	65	M17	7,0
150891	Vijak stojalni 10x70 DIN571	10,0	70	M17	7,0
151256	Vijak stojalni 10x80 DIN571	10,0	80	M17	7,0
150732	Vijak stojalni 10x90 DIN571	10,0	90	M17	7,0
150736	Vijak stojalni 10x100 DIN571	10,0	100	M17	7,0
150892	Vijak stojalni 10x110 DIN571	10,0	110	M17	7,0
151260	Vijak stojalni 10x120 DIN571	10,0	120	M17	7,0
150893	Vijak stojalni 10x130 DIN571	10,0	130	M17	7,0
151257	Vijak stojalni 10x140 DIN571	10,0	140	M17	7,0
150894	Vijak stojalni 10x150 DIN571	10,0	150	M17	7,0
151261	Vijak stojalni 10x160 DIN571	10,0	160	M17	7,0
150895	Vijak stojalni 10x170 DIN571	10,0	170	M17	7,0
151271	Vijak stojalni 10x180 DIN571	10,0	180	M17	7,0
150896	Vijak stojalni 10x190 DIN571	10,0	190	M17	7,0
151272	Vijak stojalni 10x200 DIN571	10,0	200	M17	7,0
151273	Vijak stojalni 10x220 DIN571	10,0	220	M17	7,0
151280	Vijak stojalni 10x240 DIN571	10,0	240	M17	7,0
150897	Vijak stojalni 10x250 DIN571	10,0	250	M17	7,0
151279	Vijak stojalni 10x260 DIN571	10,0	260	M17	7,0
150898	Vijak stojalni 10x280 DIN571	10,0	280	M17	7,0
151278	Vijak stojalni 10x300 DIN571	10,0	300	M17	7,0

Stojalni vijak s šestrobno glavno

- material: jeklo
- lesni navoj
- obdelava: belo cinkano
- narejen po standardu DIN571

STARMAN

Stojalni vijak s šestrobno glavo

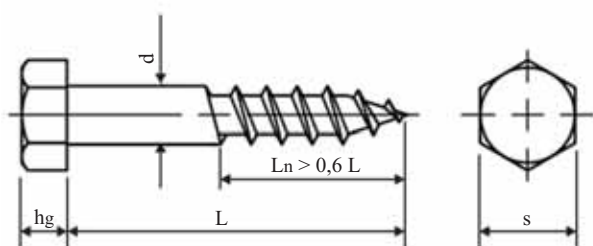

Šifra	Naziv	d (ø) mm	L mm	s	hg mm
150899	Vijak stojalni 12x40 DIN571	12,0	40	M19	8,0
151213	Vijak stojalni 12x45 DIN571	12,0	45	M19	8,0
151214	Vijak stojalni 12x50 DIN571	12,0	50	M19	8,0
151215	Vijak stojalni 12x60 DIN571	12,0	60	M19	8,0
151219	Vijak stojalni 12x70 DIN571	12,0	70	M19	8,0
151364	Vijak stojalni 12x80 DIN571	12,0	80	M19	8,0
151365	Vijak stojalni 12x90 DIN571	12,0	90	M19	8,0
151366	Vijak stojalni 12x100 DIN571	12,0	100	M19	8,0
151367	Vijak stojalni 12x110 DIN571	12,0	110	M19	8,0
151368	Vijak stojalni 12x120 DIN571	12,0	120	M19	8,0
151369	Vijak stojalni 12x130 DIN571	12,0	130	M19	8,0
151370	Vijak stojalni 12x140 DIN571	12,0	140	M19	8,0
151371	Vijak stojalni 12x150 DIN571	12,0	150	M19	8,0
151372	Vijak stojalni 12x160 DIN571	12,0	160	M19	8,0
151373	Vijak stojalni 12x170 DIN571	12,0	170	M19	8,0
151262	Vijak stojalni 12x180 DIN571	12,0	180	M19	8,0
151374	Vijak stojalni 12x190 DIN571	12,0	190	M19	8,0
151375	Vijak stojalni 12x200 DIN571	12,0	200	M19	8,0
151376	Vijak stojalni 12x220 DIN571	12,0	220	M19	8,0
151377	Vijak stojalni 12x240 DIN571	12,0	240	M19	8,0
151378	Vijak stojalni 12x250 DIN571	12,0	250	M19	8,0
151379	Vijak stojalni 12x260 DIN571	12,0	260	M19	8,0
151380	Vijak stojalni 12x280 DIN571	12,0	280	M19	8,0
151381	Vijak stojalni 12x300 DIN571	12,0	300	M19	8,0
151275	Vijak stojalni 12x320 DIN571	12,0	320	M19	8,0
151382	Vijak stojalni 12x340 DIN571	12,0	340	M19	8,0
151383	Vijak stojalni 12x360 DIN571	12,0	360	M19	8,0

Stojalni vijak s šestrobno glavo

- material: jeklo
- lesni navoj
- obdelava: belo cinkano
- narejen po standardu DIN571

STARMAN

Montažni vijak

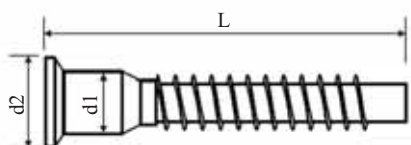

križna zareza



hex zareza

Šifra	Naziv	d1(ø) mm	L mm	d2 (ø) mm
150393	Vijak montažni 5,0x50 imbus	5	50	7,5
150227	Vijak montažni 7,0x40 imbus	7	40	10
150218	Vijak montažni 7,0x50 imbus	7	50	10
150210	Vijak montažni 7,0x50 križni	7	50	10
150221	Vijak montažni 7,0x70 imbus	7	70	10

Montažni vijak

- material: jeklo
- obdelava: belo cinkano

Povezovalni vijak

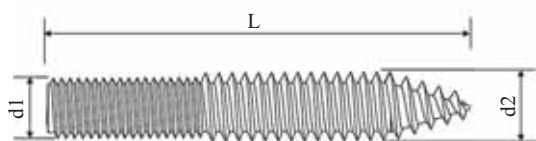

Šifra	Naziv	d1	L mm	d2 (ø) mm
150216	Vijak povezovalni M6x50 mm	M6	50	6,3
150199	Vijak povezovalni M6x60 mm	M6	60	6,3
150214	Vijak povezovalni M6x70 mm	M6	70	6,3
150212	Vijak povezovalni M6x80 mm	M6	80	6,3
150239	Vijak povezovalni M6x90 mm	M6	90	6,3
150254	Vijak povezovalni M8x40 mm	M8	40	8,5
150292	Vijak povezovalni M8x50 mm	M8	50	8,5
150228	Vijak povezovalni M8x60 mm	M8	60	8,5
150213	Vijak povezovalni M8x70 mm	M8	70	8,5
150219	Vijak povezovalni M8x80 mm	M8	80	8,5
150211	Vijak povezovalni M8x90 mm	M8	90	8,5
150223	Vijak povezovalni M8x100 mm	M8	100	8,5
150183	Vijak povezovalni M8x120 mm	M8	120	8,5
150078	Vijak povezovalni M10x50 mm	M10	50	10,7
150244	Vijak povezovalni M10x60 mm	M10	60	10,7
150084	Vijak povezovalni M10x70 mm	M10	70	10,7
150224	Vijak povezovalni M10x100 mm	M10	100	10,7
095933	Vijak povezovalni M10x140 mm	M10	140	10,7

Povezovalni vijak

- material: jeklo
- obdelava: belo cinkano
- lesni in metrični navoj

STARMAN

Kljukica za obešanje

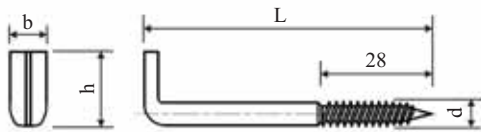

Šifra	Naziv	d (ø) mm	L mm	h mm	b mm
080813	Kljukica za obešanje 5,4x63 mm	5,4	63	17	7

Kljukica za obešanje

- za vijačenje v les ali v zidni vložek
- zareza v glavi za izvijač
- lesni navoj
- obdelava: belo cinkano

Euro vijak

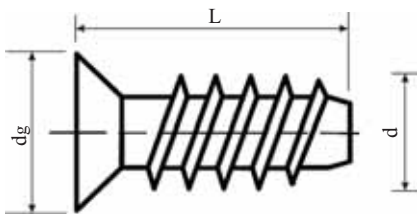

Šifra	Naziv	d (ø) mm	L mm	dg (ø) mm
150222	Vijak Euro 6x10 661.1000 HG	6,0	10	8
150217	Vijak Euro 6x11,5 661.1150 HG	6,0	11,5	8
150229	Vijak Euro 6x14,5 661.1450 HG	6,0	14,5	8
150252	Vijak Euro 6,3x9	6,3	9	8
150250	Vijak Euro 6,3x11	6,3	11	8
150215	Vijak Euro 6,3x13	6,3	13	8

Euro vijak

- obdelava: belo cinkano
- zareza v glavi: križna PZ2

Vijak za mavčne plošče

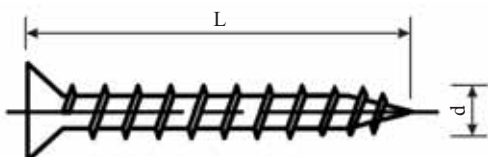

Šifra	Naziv	d (ø) mm	L mm
043550	MEA vijak tro. GL 3,9x25 F fini navoj	3,9	25
043551	MEA vijak tro. GL 3,9x35 F fini navoj	3,9	35
043552	MEA vijak tro. GL 3,9x45 F fini navoj	3,9	45

Vijak za mavčne plošče

- fini navoj
- zareza v glavi: križna PH

STARMAN

Vijak s šestrobno glavo

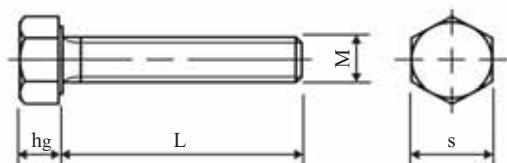

Šifra	Naziv	M	L mm	s mm	hg mm
151329	Vijak ZN M4x25-8.8 DIN933	M4	25	7	2,8
151337	Vijak ZN M5x25-8.8 DIN933	M5	25	8	3,5
151341	Vijak ZN M5x30-8.8 DIN933	M5	30	8	3,5
151338	Vijak ZN M5x40-8.8 DIN933	M5	40	8	3,5
151342	Vijak ZN M5x50-8.8 DIN933	M5	50	8	3,5
087305	Vijak ZN M6x12-8.8 DIN933	M6	12	10	4,0
087308	Vijak ZN M6x16-8.8 DIN933	M6	16	10	4,0
087309	Vijak ZN M6x18-8.8 DIN933	M6	18	10	4,0
150479	Vijak ZN M6x20-8.8 DIN933	M6	20	10	4,0
150478	Vijak ZN M6x25-8.8 DIN933	M6	25	10	4,0
150413	Vijak ZN M6x30-8.8 DIN933	M6	30	10	4,0
150427	Vijak ZN M6x35-8.8 DIN933	M6	35	10	4,0
150431	Vijak ZN M6x40-8.8 DIN933	M6	40	10	4,0
150437	Vijak ZN M6x45-8.8 DIN933	M6	45	10	4,0
151325	Vijak ZN M6x50-8.8 DIN933	M6	50	10	4,0
151323	Vijak ZN M6x55-8.8 DIN933	M6	55	10	4,0
151326	Vijak ZN M6x60-8.8 DIN933	M6	60	10	4,0
150428	Vijak ZN M6x70-8.8 DIN933	M6	70	10	4,0
150444	Vijak ZN M6x80-8.8 DIN933	M6	80	10	4,0
150443	Vijak ZN M6x100-8.8 DIN933	M6	100	10	4,0
087323	Vijak ZN M8x12-8.8 DIN933	M8	12	13	5,3
087319	Vijak ZN M8x16-8.8 DIN933	M8	16	13	5,3
150420	Vijak ZN M8x20-8.8 DIN933	M8	20	13	5,3
150418	Vijak ZN M8x25-8.8 DIN933	M8	25	13	5,3
150414	Vijak ZN M8x30-8.8 DIN933	M8	30	13	5,3
150419	Vijak ZN M8x35-8.8 DIN933	M8	35	13	5,3
150415	Vijak ZN M8x40-8.8 DIN933	M8	40	13	5,3
087314	Vijak ZN M8x45-8.8 DIN933	M8	45	13	5,3
150432	Vijak ZN M8x50-8.8 DIN933	M8	50	13	5,3
150440	Vijak ZN M8x55-8.8 DIN933	M8	55	13	5,3
150935	Vijak ZN M8x60-8.8 DIN933	M8	60	13	5,3
150411	Vijak ZN M8x70-8.8 DIN933	M8	70	13	5,3
151324	Vijak ZN M8x80-8.8 DIN933	M8	80	13	5,3
150417	Vijak ZN M8x90-8.8 DIN933	M8	90	13	5,3
015134	Vijak ZN M8x100-8.8 DIN933	M8	100	13	5,3
151315	Vijak ZN M8x120-8.8 DIN933	M8	120	13	5,3

Vijak s šestrobno glavo

- material: jeklo
- kakovost: 8.8
- obdelava: belo cinkano
- cel navoj
- narejen po standardu DIN933

STARMAN

Vijak s šestrobno glavo

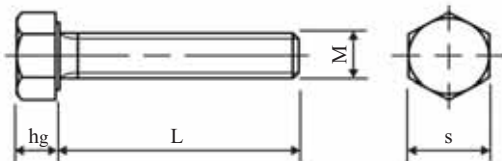

Šifra	Naziv	M	L mm	s mm	hg mm
087311	Vijak ZN M10x20-8.8 DIN933	M10	20	17	6,4
087312	Vijak ZN M10x25-8.8 DIN933	M10	25	17	6,4
087313	Vijak ZN M10x30-8.8 DIN933	M10	30	17	6,4
087306	Vijak ZN M10x35-8.8 DIN933	M10	35	17	6,4
087307	Vijak ZN M10x40-8.8 DIN933	M10	40	17	6,4
087310	Vijak ZN M10x45-8.8 DIN933	M10	45	17	6,4
087315	Vijak ZN M10x50-8.8 DIN933	M10	50	17	6,4
087316	Vijak ZN M10x60-8.8 DIN933	M10	60	17	6,4
087322	Vijak ZN M10x70-8.8 DIN933	M10	70	17	6,4
087317	Vijak ZN M10x80-8.8 DIN933	M10	80	17	6,4
087325	Vijak ZN M10x100-8.8 DIN933	M10	100	17	6,4
087324	Vijak ZN M12x20-8.8 DIN933	M12	20	19	7,5
087320	Vijak ZN M12x25-8.8 DIN933	M12	25	19	7,5
150430	Vijak ZN M12x50-8.8 DIN933	M12	50	19	7,5
150416	Vijak ZN M12x70-8.8 DIN933	M12	70	19	7,5

Vijak s šestrobno glavo

- material: jeklo
- kakovost: 8.8
- obdelava: belo cinkano
- cel navoj
- narejen po standardu DIN933

STARMAN

Sponski vijak

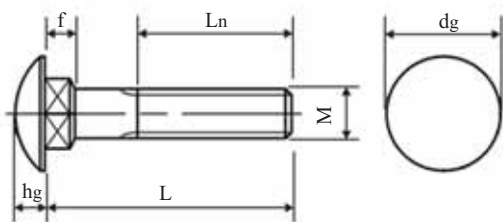

Šifra	Naziv	M	L mm	Ln mm	dg mm
151246	Vijak sponski M5x25 Zn DIN603	M5	25	16	13,55
151227	Vijak sponski M5x30 Zn DIN603	M5	30	16	13,55
151240	Vijak sponski M5x35 Zn DIN603	M5	35	16	13,55
151234	Vijak sponski M5x40 Zn DIN603	M5	40	16	13,55
151259	Vijak sponski M5x45 Zn DIN603	M5	45	16	13,55
151235	Vijak sponski M5x50 Zn DIN603	M5	50	16	13,55
151314	Vijak sponski M5x55 Zn DIN603	M5	55	16	13,55
151230	Vijak sponski M5x70 Zn DIN603	M5	70	16	13,55
151228	Vijak sponski M5x80 Zn DIN603	M5	80	16	13,55
051213	Vijak sponski M6x20 Zn DIN603	M6	20	18	16,55
151204	Vijak sponski M6x25 Zn DIN603	M6	25	18	16,55
151205	Vijak sponski M6x30 Zn DIN603	M6	30	18	16,55
151206	Vijak sponski M6x35 Zn DIN603	M6	35	18	16,55
151207	Vijak sponski M6x40 Zn DIN603	M6	40	18	16,55
151233	Vijak sponski M6x45 Zn DIN603	M6	45	18	16,55
150425	Vijak sponski M6x50 Zn DIN603	M6	50	18	16,55
151208	Vijak sponski M6x55 Zn DIN603	M6	55	18	16,55
150422	Vijak sponski M6x60 Zn DIN603	M6	60	18	16,55
151209	Vijak sponski M6x70 Zn DIN603	M6	70	18	16,55
150426	Vijak sponski M6x80 Zn DIN603	M6	80	18	16,55
151210	Vijak sponski M6x90 Zn DIN603	M6	90	18	16,55
151211	Vijak sponski M6x100 Zn DIN603	M6	100	18	16,55
151212	Vijak sponski M6x120 Zn DIN603	M6	120	18	16,55

Sponski vijak

- material: jeklo
- obdelava: belo cinkano
- lečasta glava
- kvadratni rob pod glavo preprečuje vrtenje vijaka
- delni metrični navoj
- višina glave hg:
 - vijak M5: 3,3 mm
 - vijak M6: 3,9 mm
- višina kvadratnega roba f:
 - vijak M5: 4,1 mm
 - vijak M6: 4,6 mm
- narejen po standardu DIN603
- kakovost: 5.8

STARMAN

Sponski vijak

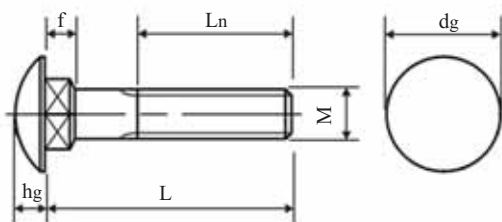

Šifra	Naziv	M	L mm	Ln mm	dg mm
150449	Vijak sponski M8x20 Zn DIN603	M8	20	22	20,65
150462	Vijak sponski M8x25 Zn DIN603	M8	25	22	20,65
150448	Vijak sponski M8x30 Zn DIN603	M8	30	22	20,65
151241	Vijak sponski M8x35 Zn DIN603	M8	35	22	20,65
150423	Vijak sponski M8x40 Zn DIN603	M8	40	22	20,65
150376	Vijak sponski M8x45 Zn DIN603	M8	45	22	20,65
151216	Vijak sponski M8x50 Zn DIN603	M8	50	22	20,65
151224	Vijak sponski M8x55 Zn DIN603	M8	55	22	20,65
150424	Vijak sponski M8x60 Zn DIN603	M8	60	22	20,65
151231	Vijak sponski M8x65 Zn DIN603	M8	65	22	20,65
151217	Vijak sponski M8x70 Zn DIN603	M8	70	22	20,65
151223	Vijak sponski M8x80 Zn DIN603	M8	80	22	20,65
150429	Vijak sponski M8x90 Zn DIN603	M8	90	22	20,65
150410	Vijak sponski M8x100 Zn DIN603	M8	100	22	20,65
151220	Vijak sponski M8x110 Zn DIN603	M8	110	22	20,65
151218	Vijak sponski M8x120 Zn DIN603	M8	120	22	20,65
151221	Vijak sponski M8x130 Zn DIN603	M8	130	28	20,65
151222	Vijak sponski M8x140 Zn DIN603	M8	140	28	20,65
151225	Vijak sponski M8x150 Zn DIN603	M8	150	28	20,65
151226	Vijak sponski M8x160 Zn DIN603	M8	160	28	20,65
151247	Vijak sponski M10x25 Zn DIN603	M10	25	26	24,65
151248	Vijak sponski M10x30 Zn DIN603	M10	30	26	24,65
151303	Vijak sponski M10x40 Zn DIN603	M10	40	26	24,65
151229	Vijak sponski M10x70 Zn DIN603	M10	70	26	24,65
151232	Vijak sponski M10x100 Zn DIN603	M10	100	26	24,65
151236	Vijak sponski M10x120 Zn DIN603	M10	120	26	24,65
151242	Vijak sponski M10x140 Zn DIN603	M10	140	32	24,65
151239	Vijak sponski M10x220 Zn DIN603	M10	220	45	24,65
151237	Vijak sponski M12x55 Zn DIN603	M12	55	30	30,65
151245	Vijak sponski M12x80 Zn DIN603	M12	80	30	30,65
151238	Vijak sponski M12x100 Zn DIN603	M12	100	30	30,65

Sponski vijak

- material: jeklo
- obdelava: belo cinkano
- lečasta glava
- kvadratni rob pod glavo preprečuje vrtenje vijaka
- delni metrični navoj
- višina kvadratnega roba f:
 - vijak M8: 5,6 mm
 - vijak M10: 6,6 mm
 - vijak M12: 8,75 mm
- višina glave hg:
 - vijak M8: 4,88 mm
 - vijak M10: 5,38 mm
 - vijak M12: 6,95 mm
- kakovost: 5.8
- narejen po standardu DIN603

STARMAN

Vijak za ročaj

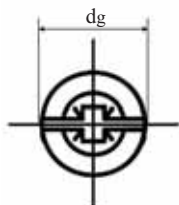
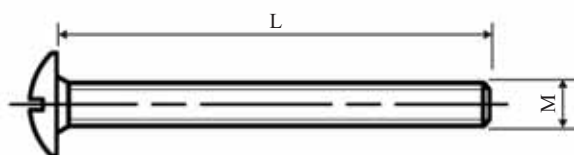

kombinirana zareza

Šifra	Naziv	M	L mm	dg (ø) mm
150202	Vijak za ročaj-M4x10	M4	10	9,5
150220	Vijak za ročaj-M4x16	M4	16	9,5
150203	Vijak za ročaj-M4x20	M4	20	9,5
150204	Vijak za ročaj-M4x22,5	M4	22,5	9,5
150206	Vijak za ročaj-M4x25	M4	25	9,5
150247	Vijak za ročaj-M4x28	M4	28	9,5
150205	Vijak za ročaj-M4x30	M4	30	9,5
150209	Vijak za ročaj-M4x35	M4	35	9,5
150248	Vijak za ročaj-M4x38	M4	38	9,5
150207	Vijak za ročaj-M4x40	M4	40	9,5
150245	Vijak za ročaj-M4x42	M4	42	9,5
150208	Vijak za ročaj-M4x45	M4	45	9,5
150226	Vijak za ročaj-M4x50	M4	50	9,5
150378	Vijak za ročaj-M4x55	M4	55	9,5
150249	Vijak za ročaj-M4x60	M4	60	9,5

Vijak za ročaj

- material: jeklo
- obdelava: belo cinkano
- zareza v glavi: kombinirana ravna in križna zareza PZ2

Vijak za posteljno okovje

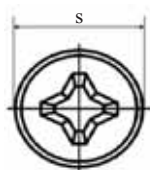
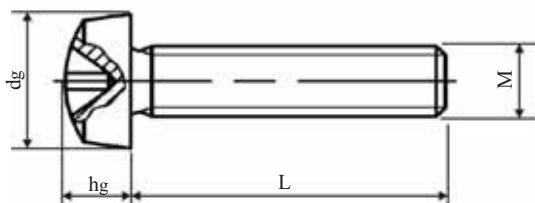

Šifra	Naziv	M	L mm	dg (ø) mm
150135	Vijak za posteljno okovje M6x10 DIN 7985	M6	10	12
150131	Vijak za posteljno okovje M6x12 DIN 7985	M6	12	12

Vijak za posteljno okovje

- metrični navoj
- material: jeklo
- obdelava: belo cinkan
- višina glave hg: 4,6 mm
- narejen po standardu DIN 7985
- kakovost: 5,8
- zareza v glavi: križna PH3

STARMAN

Vezni vijak

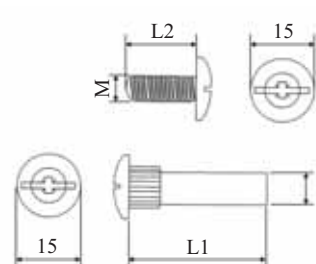

Šifra	Naziv	M	L1 mm	L2 mm
150080	Vijak vezni M4x15	M4	15	15
150256	Vijak vezni M4x27	M4	27	15
150257	Vijak vezni M4x30	M4	30	15
150258	Vijak vezni M4x35	M4	35	15
150480	Vijak vezni M6x31	M6	31	14
150481	Vijak vezni M6x38	M6	38	14

Vezni vijak

- material: jeklo
- obdelava: nikljano
- za spajanje elementov
- rebrast obroč preprečuje vrtenje
- izvrtina:
 - vijak M4: \varnothing 5 mm
 - vijak M6: \varnothing 8 mm
- zareza v glavi: kombinirana PZ2 in ravna
- če uporabljamo daljši vijak lahko spajamo debelejše elemente

STARMAN

Navojna palica

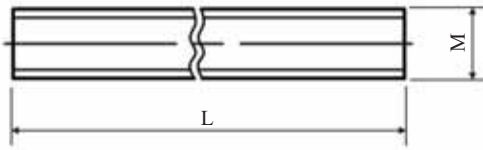

Šifra	Naziv	M	L mm
150225	Navojna palica M4x1000 mm Zn DIN975	M4	1000
150147	Navojna palica M5x1000 mm Zn DIN975	M5	1000
150155	Navojna palica M6x1000 mm Zn DIN975	M6	1000
150156	Navojna palica M8x1000 mm Zn DIN975	M8	1000
150157	Navojna palica M10x1000 mm Zn DIN975	M10	1000
150158	Navojna palica M12x1000 mm Zn DIN975	M12	1000
150159	Navojna palica M14x1000 mm Zn DIN975	M14	1000
150165	Navojna palica M16x1000 mm Zn DIN975	M16	1000
150136	Navojna palica M18x1000 mm Zn DIN975	M18	1000
150137	Navojna palica M20x1000 mm Zn DIN975	M20	1000
150082	Navojna palica M22x1000 mm Zn DIN975	M22	1000
150083	Navojna palica M24x1000 mm Zn DIN975	M24	1000

Navojna palica

- obdelava: belo cinkano
- narejena po standardu DIN975

Navojno stebilo

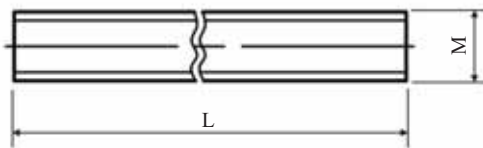

Šifra	Naziv	M	L mm
150403	Navojno stebilo M6x57 mm Zn	M6	57
150146	Navojno stebilo M6x60 mm	M6	60
150170	Navojno stebilo M6x70 mm Zn	M6	70
150172	Navojno stebilo M6x90 mm	M6	90
150174	Navojno stebilo M8x60 mm	M8	60
150886	Navojno stebilo M8x60 mm Zn DIN938	M8	60
150175	Navojno stebilo M8x70 mm	M8	70
095890	X-12.08.647-2 Navojno stebilo M8x95 mm	M8	95

Navojno stebilo

- obdelava: surovo ali belo cinkano

STARMAN

Matica M

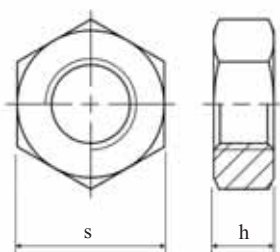

Šifra	Naziv	M	h mm	s mm
150814	Matica M4 Zn DIN 934	M4	3,2	7
150759	Matica M5 Zn DIN 934	M5	4,0	8
150760	Matica M6 Zn DIN 934	M6	5,0	10
150761	Matica M8 Zn DIN 934	M8	6,5	13
150762	Matica M10 Zn DIN 934	M10	8,0	17
150763	Matica M12 Zn DIN 934	M12	10,0	19
150753	Matica M14 Zn DIN 934	M14	11,0	22
150754	Matica M16 Zn DIN 934	M16	13,0	24
150755	Matica M18 Zn DIN 934	M18	15,0	27
150756	Matica M20 Zn DIN 934	M20	16,0	30

Matica

- metrični navoj
- obdelava: belo cinkano
- narejena po standardu DIN934
- kakovost: 8

Varovalna matica

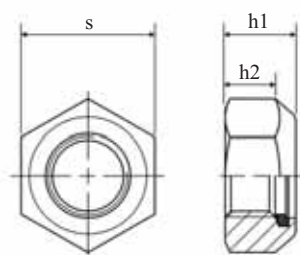

Šifra	Naziv	M	h1 mm	h2 mm	s mm
150776	Matica varovalna M3 DIN985	M3	4	2,4	5,5
150831	Matica varovalna M4 DIN985	M4	5	2,9	7
150771	Matica varovalna M5 DIN985	M5	5	3,2	8
150749	Matica varovalna M6 DIN985	M6	6	4,0	10
150750	Matica varovalna M8 DIN985	M8	8	5,5	13
150730	Matica varovalna M10 DIN985	M10	10	6,5	17
150855	Matica varovalna M12 DIN985	M12	12	8,0	19
150876	Matica varovalna M14 DIN985	M14	14	9,5	22
150883	Matica varovalna M16 DIN985	M16	16	10,5	24

Varovalna matica

- metrični navoj
- varovalna guma preprečuje odvijanje matice
- obdelava: belo cinkano
- narejena po standardu DIN985
- kakovost: 8

Pokrivna matica

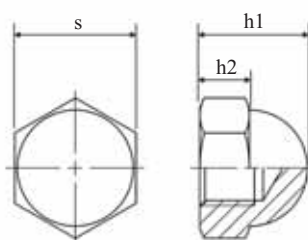

Šifra	Naziv	M	h1 mm	h2 mm	s mm
150822	Matica M6 Zn zaprta DIN1587	M6	12	8,29	10
150726	Matica M8 Zn zaprta DIN1587	M8	15	11,35	13
150772	Matica M10 Zn zaprta DIN1587	M10	18	13,35	17
150811	Matica M12 Zn zaprta DIN1587	M12	22	16,35	19
150887	Matica M14 Zn zaprta DIN1587	M14	25	18,35	22
150888	Matica M16 Zn zaprta DIN1587	M16	28	21,42	24

Pokrivna matica

- kovinska
- obdelava: belo cinkano
- narejena po standardu DIN1587

STARMAN

Stročna matica

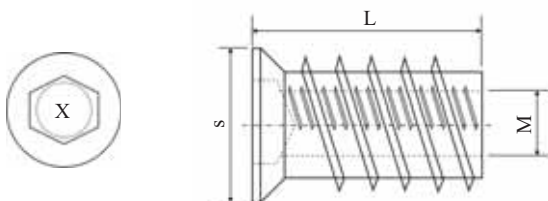

Šifra	Naziv	M	L mm	s (ø) mm	X (hex) mm
150154	Matica stročna M4x10	M4	10	8	4
150151	Matica stročna M6x13	M6	13	12	6
150153	Matica stročna M6x15	M6	15	12	6
150150	Matica stročna M6x20	M6	20	12	6
150148	Matica stročna M8x15	M8	15	14	8
150152	Matica stročna M8x20	M8	20	14	8
150145	Matica stročna M8x24	M8	24	14	8
150149	Matica stročna M10x20	M10	20	17	10

Stročna matica

- kovinska
- notranji navoj po celi dolžini
- glava za imbus ključ
- obdelava: belo cinkano

Vtisna matica

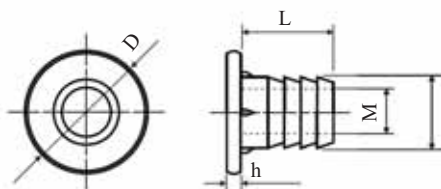

Šifra	Naziv	M	L mm	D (ø) mm	h mm
150160	Matica vtisna M6x14	M6	14	17	1,5
150144	Matica vtisna M8x16	M8	16	19	2

Vtisna matica

- kovinska
- notranji navoj po celi dolžini
- obdelava: belo cinkano

Matica - Unit

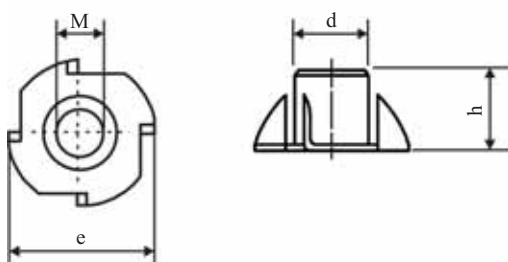

Šifra	Naziv	M	h mm	d (ø) mm	e mm
150173	Matica unit M4x7 mm	M4	7	5	16
150142	Matica unit M5x8 surova	M5	8	6,5	19
150139	Matica unit M6x9 mm	M6	9	8	19
150141	Matica unit M8x10 mm	M8	10	10	22
128106	Matica unit M8x14 mm	M8	14	9,5	22
150143	Matica unit M10x12 mm	M10	12	12	25

Matica - Unit

- kovinska
- za tapetnike
- matica ima kavljce za pribijanje
- obdelava: belo cinkano

STARMAN

Okrasna matica

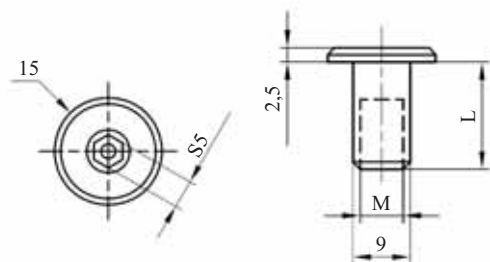

Šifra	Naziv	M	L mm
150793	Matica okrasna M6x12 MS	M6	12
150803	Matica okrasna M6x15 MS	M6	15
150792	Matica okrasna M6x18 MS	M6	18

Okrasna matica

- kovinska
- zareza v glavi: hex 5 mm
- obdelava: rumeno cinkano

Prečna matica

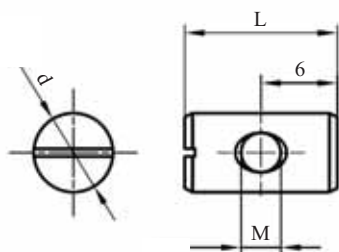

Šifra	Naziv	M	L mm	d (ø) mm
150789	Matica prečna M6 fi 10x12	M6	12	10
150826	Matica prečna M6 fi 10x14	M6	14	10
150836	Matica prečna M6 fi 12x14	M6	14	12

Prečna matica

- material: jeklo
- obdelava: belo cinkano
- zareza v glavi: ravna

Razcepna matica

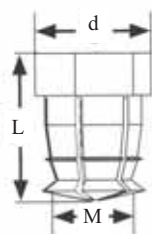

Šifra	Naziv	M mm	L mm	d (ø) mm
128110	X-Matica razcepna fi 8x11,5 M6 s kroglico	6	11,5	8

Razcepna matica

- material: medenina
- obdelava: natur
- kroglica za ekstra razširitev

STARMAN

Matica KEA

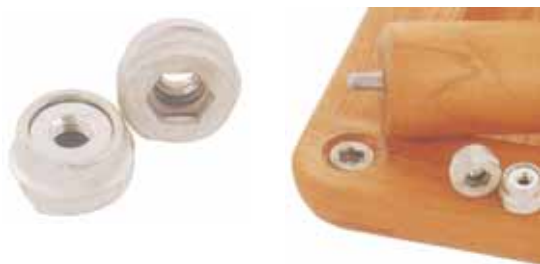

Šifra	Naziv	M	d (ø) mm
128080	X-Matica KEA M8x15 mm fi 22 mm	M8	22

Matica KEA

- za uporabo pri nogah za mize
- luknja: \varnothing 22 mm x 15 mm
- notranji navoj: M8
- material: zamak

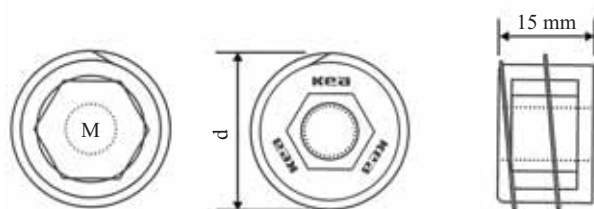

Podložka

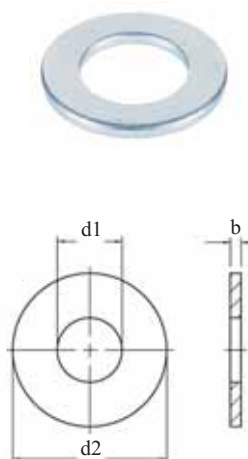

Šifra	Naziv	d1 (ø) mm	d2 (ø) mm	b mm
150843	Podložka M4 Zn DIN 125	4,3	9	0,8
150824	Podložka M5 Zn DIN 125	5,3	10	1,0
150764	Podložka M6 Zn DIN 125	6,4	12	1,6
150765	Podložka M8 Zn DIN 125	8,4	16	1,6
150766	Podložka M10 Zn DIN 125	10,5	20	2,0
150767	Podložka M12 Zn DIN 125	13,0	24	2,5
150768	Podložka M14 Zn DIN 125	15,0	28	2,5
150769	Podložka M16 Zn DIN 125	17,0	30	3,0
150770	Podložka M18 Zn DIN 125	19,0	34	3,0
150810	Podložka M20 Zn DIN 125	21,0	37	3,0

Podložka

- obdelava: belo cinkano
- narejena po standardu DIN125

Podložka - široka

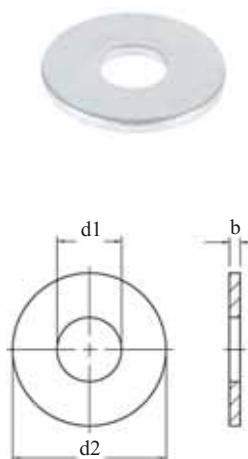

Šifra	Naziv	d1 (ø) mm	d2 (ø) mm	b mm
150777	Podložka M4 Zn široka DIN 9021	4,3	12	1,0
150779	Podložka M5 Zn široka DIN 9021	5,3	15	1,2
150780	Podložka M6 Zn široka DIN 9021	6,4	18	1,6
150781	Podložka M8 Zn široka DIN 9021	8,4	24	2,0
150782	Podložka M10 Zn široka DIN 9021	10,5	30	2,5
150783	Podložka M12 Zn široka DIN 9021	13,0	37	3,0
150784	Podložka M14 Zn široka DIN 9021	15,0	44	3,0
150785	Podložka M16 Zn široka DIN 9021	17,0	50	3,0
150786	Podložka M18 Zn široka DIN 9021	20,0	56	4,0
150787	Podložka M20 Zn široka DIN 9021	22,0	60	4,0

Podložka - široka

- za večje obremenitve
- obdelava: belo cinkano
- narejena po standardu DIN9021

STARMAN

Centrirni čep

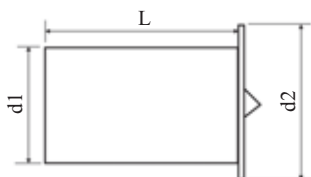

Šifra	Naziv	d1 (ø) mm	d2 (ø) mm	L mm
150722	Čep centrirni 6 mm pakirano 20 kos	6	8	10
150720	Čep centrirni 8 mm pakirano 20 kos	8	12	10
150721	Čep centrirni 10 mm pakirano 20 kos	10	12	12
150723	Čep centrirni 12 mm pakirano 20 kos	12	15	12

Centrirni čep

- kovinski
- obdelava: belo cinkano
- pakirano: 20 kos

Zaskočna ploščica

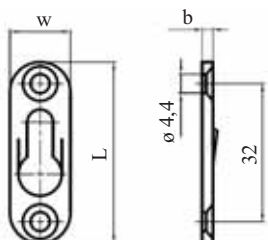

Šifra	Naziv	L mm	w mm	b mm
099437	Ploščica zaskočna 161.42.40	42	14	2,5

Zaskočna ploščica

- kovinska
- obdelava: belo cinkano

Imbus ključ

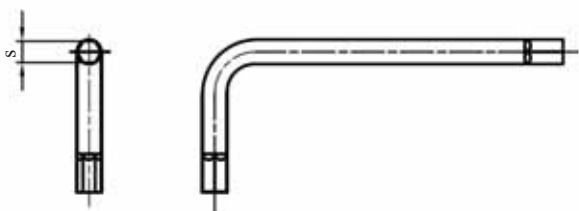

Šifra	Naziv	s mm
150820	Ključ imbus 3 mm kaljen	3
150817	Ključ imbus 4 mm kaljen	4
150818	Ključ imbus 5 mm kaljen	5
150819	Ključ imbus 6 mm cinkan	6

Imbus ključ

- kovinski
- obdelava: belo cinkano

STARMAN

Garnitura za spajanje pultov

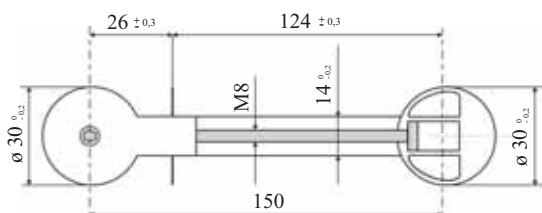

Garnitura za spajanje pultov

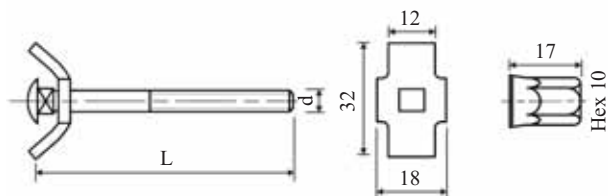

Kriva podložka

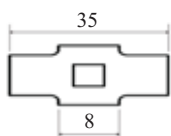

Matica Tropical

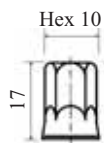

Ključ za matico Tropical



Šifra	Naziv	ø mm	L mm	Vijak
300022	Quick connector-za spajanje M8x150 fi 30	30	150	M8

Garnitura za spajanje pultov Quick conector

- hitro spajanje
- enostavna montaža
- nastavljanje z imbus ključem ali imbus nastavkom 6 mm
- za hitro nastavljanje uporabimo vijahnik
- minimalna debelina pulta: 25 mm
- globina vrtanja: 21 ± 0.3
- garnitura vsebuje 2 spojna kompleta



Šifra	Naziv	L mm	d
080155	Garnitura za spoj pultov M6x150 mm	150	M6

Garnitura za spajanje pultov

- nastavljanje z obročnim ključem M10
- garnitura vsebuje 2 spojna kompleta in 1 obročni ključ

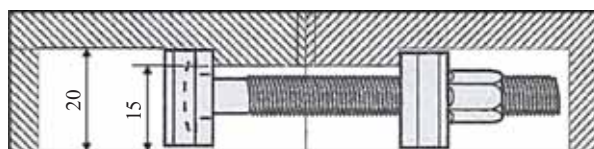
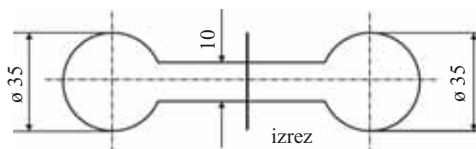

Šifra	Naziv
150790	Podložka kriva

Kriva podložka

- obdelava: belo cinkano

Šifra	Naziv
150788	Matica M6x17 Tropical

Matica Tropical

- navoj: M6

Šifra	Naziv
095141	Ključ matice Tropical

Ključ za matico Tropical

- obdelava: belo cinkano

STARMAN

Kotniki širine 15 mm

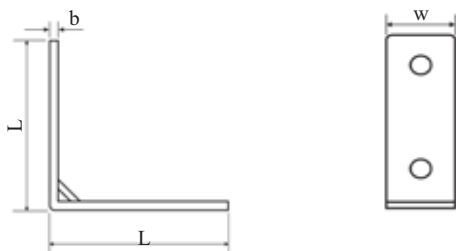

Šifra	Naziv	L mm	w mm	b mm
095626	Kotnik pohoštvni 30x30x15/2 mm 4L Zn	30	15	2
095627	Kotnik pohoštvni 40x40x15/2 mm 4L Zn	40	15	2
095625	Kotnik pohoštvni 50x50x15/2 mm 4L Zn	50	15	2
095631	Kotnik pohoštvni 60x60x15/2 mm 4L Zn	60	15	2
095632	Kotnik pohoštvni 70x70x15/2 mm 4L Zn	70	15	2
095633	Kotnik pohoštvni 80x80x15/2 mm 4L Zn	80	15	2
079202	Kotnik pohoštvni 90x90x15/2 mm 4L Zn	90	15	2
079203	Kotnik pohoštvni 100x100x15/2 mm 4L Zn	100	15	2

Kotnik

- ojačan
- obdelava: belo cinkano

Kotniki širine 17 mm

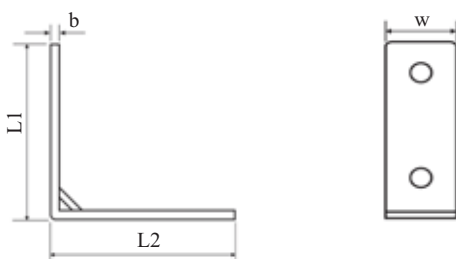

Šifra	Naziv	L1 mm	L2 mm	w mm	b mm
009565	Kotnik 30x30x17/2 mm 2L Zn	30	30	17	2
095650	Kotnik 45x55x17/2 mm 4L Zn	45	55	17	2
095669	Kotnik 70x70x17/2 mm 4L Zn	70	70	17	2

Kotnik

- ojačan
- obdelava: belo cinkano

STARMAN

Kotniki širine 21 mm

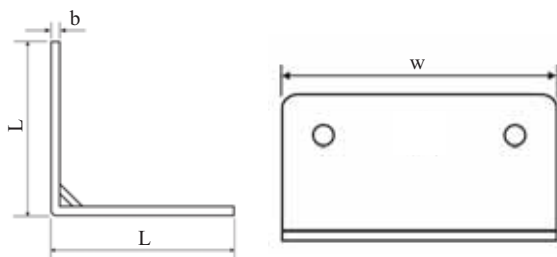

Šifra	Naziv	L mm	w mm	b mm
095641	Kotnik vezni 21x21x37/1 mm 4L Zn	21	37	1
095642	Kotnik vezni 21x21x50/1 mm 4L Zn	21	50	1
079220	Kotnik vezni 21x21x67/1 mm 4L Zn	21	67	1
095643	Kotnik vezni 21x21x86/1 mm 6L Zn	21	86	1

Kotnik

- ojačan
- obdelava: belo cinkano

Kotniki širine 30 mm

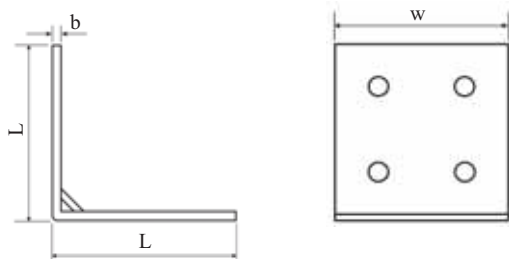

Šifra	Naziv	L mm	w mm	b mm
095629	Kotnik pohištvni 30x30x30/2 mm 8L Zn	30	30	2
095620	Kotnik pohištvni 40x40x30/2 mm 8L Zn	40	30	2
095621	Kotnik pohištvni 50x50x30/2 mm 8L Zn	50	30	2
095622	Kotnik pohištvni 60x60x30/2 mm 8L Zn	60	30	2
079205	Kotnik pohištvni 70x70x30/2 mm 8L Zn	70	30	2
095623	Kotnik pohištvni 80x80x30/2 mm 8L Zn	80	30	2
079206	Kotnik pohištvni 90x90x30/2 mm 8L Zn	90	30	2
095624	Kotnik pohištvni 100x100x30/2 mm 8L Zn	100	30	2

Kotnik

- ojačan
- obdelava: belo cinkano

STARMAN

Kotniki širine 30 mm

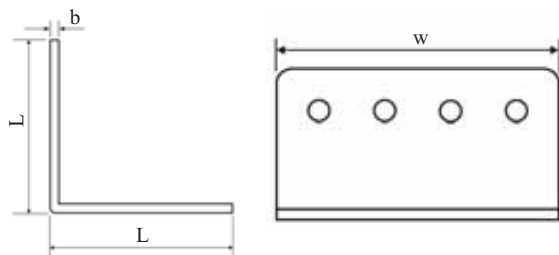

Šifra	Naziv	L mm	w mm	b mm
095676	Kotnik 30x30x55/2,5 mm 4L Zn	30	55	2,5
095665	Kotnik 30x30x80/2,5 mm 4L Zn	30	80	2,5
095656	Kotnik 30x30x155/2,5 mm 8L Zn	30	155	2,5
091153	Kotnik 30x30x180/2,5 mm 8L Zn	30	180	2,5

Kotnik

- obdelava: belo cinkano

Kotniki širine 40 mm

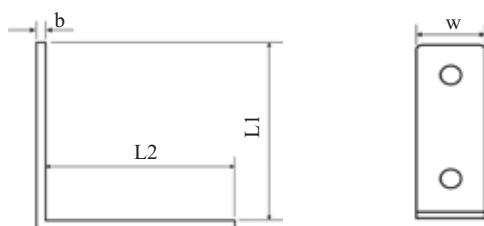

Šifra	Naziv	L1 mm	L2 mm	w mm	b mm
095628	Kotnik 150x150x40/5 mm 4L Zn	150	150	40	5
095618	Kotnik 250x150x40/5 mm 5L Siv	250	150	40	5

Kotnik

- obdelava:

kotnik 150/150/40 mm: belo cinkano

kotnik 250/150/40 mm: siv

STARMAN

Kotniki širine 45 mm

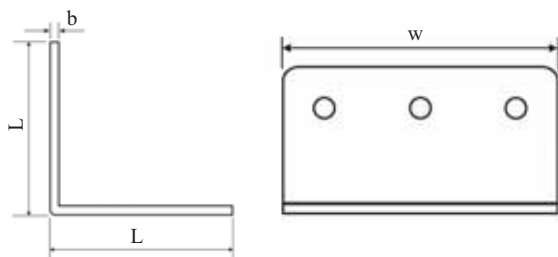

Šifra	Naziv	L mm	w mm	b mm
091150	Kotnik 45x45x100/2,5 mm 6L Zn	45	100	2,5
091155	Kotnik 45x45x155/2,5 mm 8L Zn	45	155	2,5
091154	Kotnik 45x45x200/2,5 mm 12 L Zn	45	200	2,5

Kotnik

- ojačan
- obdelava: belo cinkano

Kotniki širine 55 mm

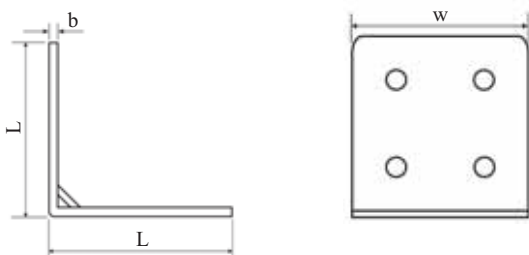

Šifra	Naziv	L mm	w mm	b mm
095619	Kotnik 40x40x55/ 2,5 mm 4L Zn	40	55	2,5
095671	Kotnik 50x50x55/2,5 mm 6L Zn	50	55	2,5
095670	Kotnik 60x60x55/2,5 mm 8L Zn	60	55	2,5
095666	Kotnik 70x70x55/2,5 mm 8L Zn	70	55	2,5
095667	Kotnik 80x80x55/2,5 mm 8L Zn	80	55	2,5
095674	Kotnik 90x90x55/2,5 mm 8L Zn	90	55	2,5

Kotnik

- ojačan
- obdelava: belo cinkano

STARMAN

Kotniki širine 55 mm

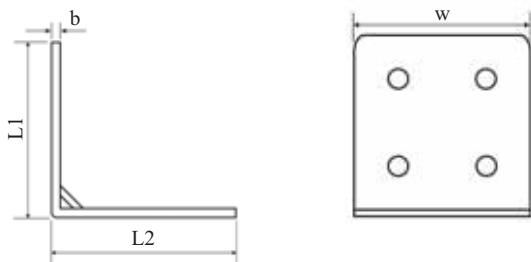

Šifra	Naziv	L1 mm	L2 mm	w mm	b mm
095677	Kotnik 30x55x55/2,5 mm 4L Zn	30	55	55	2,5
095678	Kotnik 50x70x55/2,5 mm 8L Zn	50	70	55	2,5
095654	Kotnik 50x90x55/2,5 mm 8L Zn	50	90	55	2,5
095675	Kotnik 150x100x55/3 mm 10 L Zn	150	100	55	2,5

Kotnik

- ojačan
- obdelava: belo cinkano

Kotniki širine 90 mm

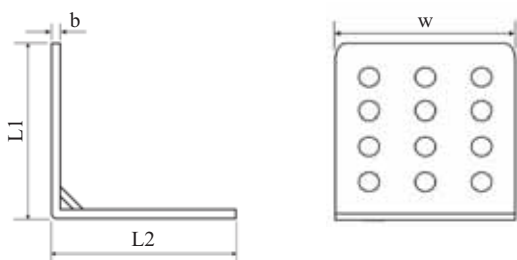

Šifra	Naziv	L1 mm	L2 mm	w mm	b mm
095660	Kotnik 70x70x90/2,5 mm 12L Zn	70	70	90	2,5
095662	Kotnik 100x65x90/2,5 mm 18L Zn	100	65	90	2,5
095661	Kotnik 100x100x90/2,5 mm 18L Zn	100	100	90	2,5
095663	Kotnik 135x135x90/2,5 mm 24L Zn	135	135	90	2,5
095664	Kotnik 170x100x90/2,5 mm 24L Zn	170	100	90	2,5

Kotnik

- ojačan
- obdelava: belo cinkano

STARMAN

Kotnik širine 11 mm

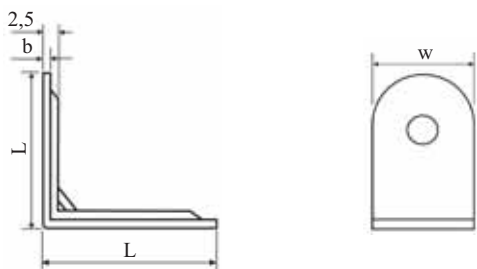

Šifra	Naziv	L mm	w mm	b mm
095635	Kotnik pohištenj 17x17x11/1 mm 2L Zn	17	11	1

Kotnik

- ojačan
- debelina: 1 mm
- celotna debelina: 2,5 mm
- obdelava: belo cinkano

Kotnik širine 15 mm

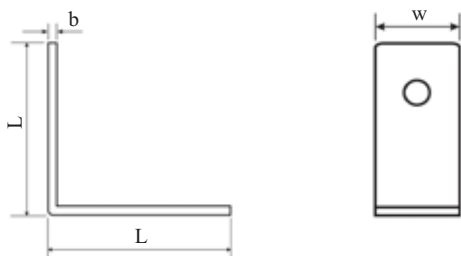

Šifra	Naziv	L mm	w mm	b mm
095653	Kotnik 20x20x15/1,5 mm 2L Zn	20	15	1,5

Kotnik

- obdelava: belo cinkano

Kotnik širine 15 mm



Šifra	Naziv	L mm	w mm	b mm
095640	Kotnik poh. 20x20x15/2 mm 2L zaokrožen	20	15	2

Kotnik

- ojačan
- obdelava: belo cinkano

STARMAN

Kotnik širine 22 mm

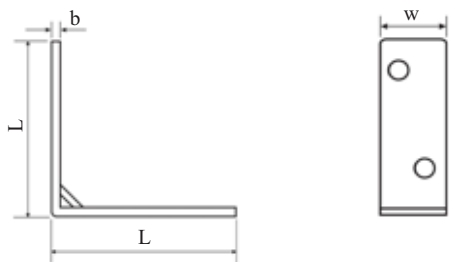

Šifra	Naziv	L mm	w mm	b mm
095668	Kotnik 40x40x22/2 mm 4L Zn	40	22	2

Kotnik

- ojačan
- obdelava: belo cinkano

Kotnik - nastavljivi širine 22 mm

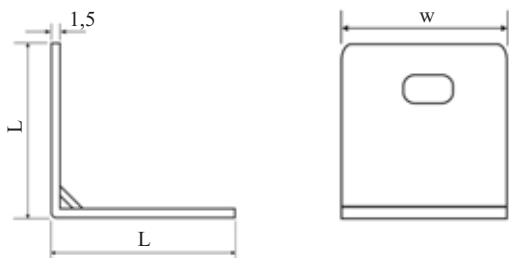

Šifra	Naziv	L mm	w mm
095651	Nosilec kotnik 25x25x22/1,5 mm nastavljivi 2L Zn	25	22

Kotnik - nastavljivi

- ojačan
- debelina: 1,5 mm
- obdelava: belo cinkano

Kotnik širine 23 mm

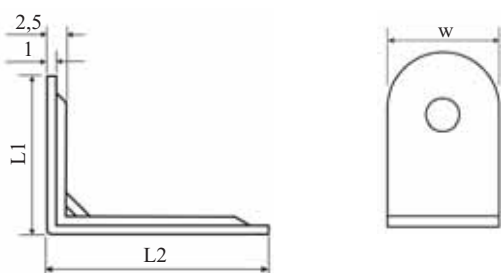

Šifra	Naziv	L1 mm	L2 mm	w mm
095040	Kotnik pohištenj 28x38x23/1 mm 2L Zn	28	38	23

Kotnik

- ojačan
- debelina: 1 mm
- celotna debelina: 2,5 mm
- obdelava: belo cinkano

STARMAN

Kotnik širine 30 mm

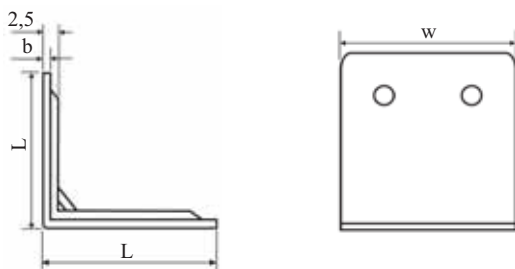

Šifra	Naziv	L mm	w mm	b mm
095041	Kotnik pohoštveni 28x28x30/1 mm 3L Zn	28	30	1

Kotnik

- ojačan
- debelina: 1 mm
- celotna debelina: 2,5 mm
- obdelava: belo cinkano

Kotnik - nastavljivi širine 30 mm

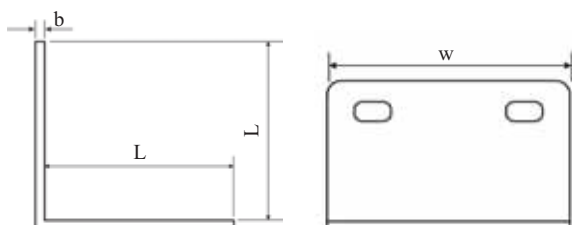

Šifra	Naziv	L mm	w mm
095652	Nosilec kotnik 30x30x50/2,5 mm nastavljivi 4L Zn	30	50

Kotnik - nastavljivi

- debelina (b): 2,5 mm
- obdelava: belo cinkano

Ploski kotnik

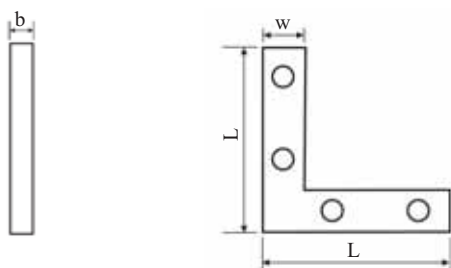

Šifra	Naziv	L mm	w mm	b mm
095658	Kotnik ploski 60x60x16/1,5 mm 4L Zn	60	16	1,5
095657	Kotnik ploski 80x80x18/1,8 mm 4L Zn	80	18	1,8
095659	Kotnik ploski 100x100x18/1,8 mm 6L Zn	100	18	1,8

Ploski kotnik

- obdelava: belo cinkano

STARMAN

Letve širine 15 mm

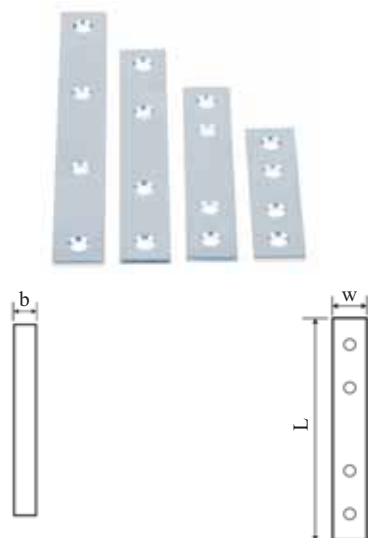

Šifra	Naziv	L mm	w mm	b mm
095550	Letev ravna 60x15/2 mm 4L Zn	60	15	2
095551	Letev ravna 80x15/2 mm 4L Zn	80	15	2
095552	Letev ravna 100x15/2 mm 4L Zn	100	15	2
095553	Letev ravna 120x15/2 mm 4L Zn	120	15	2
079209	Letev ravna 140x15/2 mm 4L Zn	140	15	2
079210	Letev ravna 160x15/2 mm 4L Zn	160	15	2
079211	Letev ravna 180x15/2 mm 4L Zn	180	15	2
079212	Letev ravna 200x15/2 mm 4L Zn	200	15	2

Ravna letev

- obdelava: belo cinkano

Letve širine 30 mm

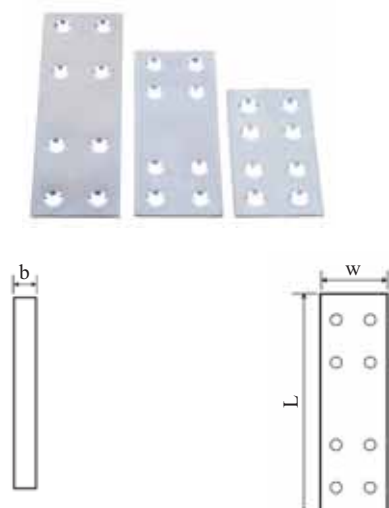

Šifra	Naziv	L mm	w mm	b mm
079213	Letev ravna 60x30/2 mm 8L Zn	60	30	2
079214	Letev ravna 80x30/2 mm 8L Zn	80	30	2
079215	Letev ravna 100x30/2 mm 8L Zn	100	30	2
095570	Letev ravna 120x30/2 mm 8L Zn	120	30	2
079216	Letev ravna 140x30/2 mm 8L Zn	140	30	2
079217	Letev ravna 160x30/2 mm 8L Zn	160	30	2
079218	Letev ravna 180x30/2 mm 8L Zn	180	30	2
095573	Letev ravna 200x30/2 mm 8L Zn	200	30	2

Ravna letev

- obdelava: belo cinkano

STARMAN

Vezna ploščica širine 22 mm

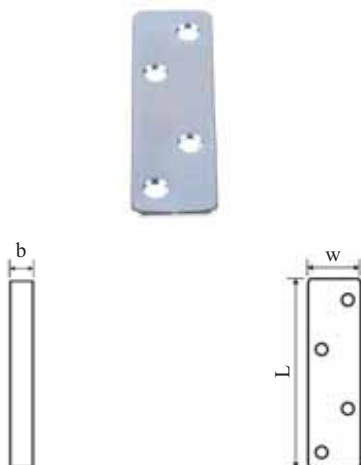

Šifra	Naziv	L mm	w mm	b mm
079259	Ploščica vezna 80x22/2 mm 4L Zn	80	22	2

Vezna ploščica

- obdelava: belo cinkano

Vezna ploščica širine 23 mm

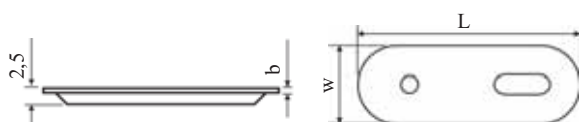

Šifra	Naziv	L mm	w mm	b mm
079256	Ploščica vezna 23x64/1 mm 2L Zn ovalna	64	23	1

Vezna ploščica

- debelina (b): 1 mm
- celotna debelina: 2,5 mm
- obdelava: belo cinkano

Vezna ploščica širine 30 mm

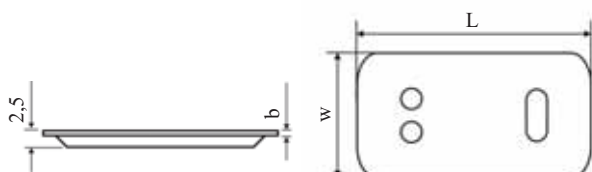

Šifra	Naziv	L mm	w mm	b mm
079255	Ploščica vezna 30x54/1 mm 3L Zn ovalna	54	30	1

Vezna ploščica

- debelina: 1 mm
- celotna debelina: 2,5 mm
- obdelava: belo cinkano

STARMAN

Vezne ploščice širine 40 mm

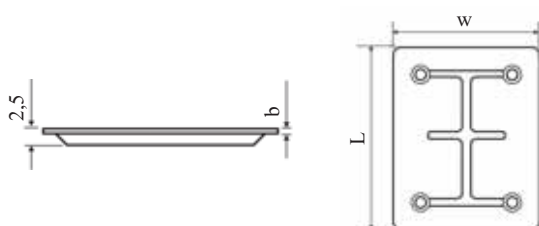

Šifra	Naziv	L mm	w mm	b mm
079207	Ploščica vezna 37x40/1 mm 4L Zn	37	40	1
095560	Ploščica vezna 50x40/1 mm 4L Zn	50	40	1
095561	Ploščica vezna 67x40/1 mm 4L Zn	67	40	1
079219	Ploščica vezna 86x40/1 mm 4L Zn	86	40	1

Vezna ploščica

- debelina: 1 mm
- celotna debelina: 2,5 mm
- obdelava: belo cinkano

Vezna ploščica širine 50 mm

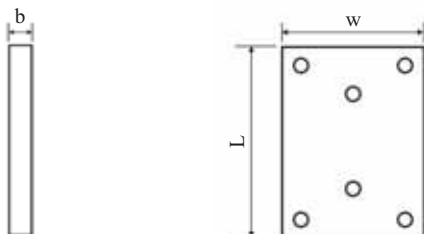

Šifra	Naziv	L mm	w mm	b mm
099458	Ploščica vezna 80x50/1,5 mm 6L Zn	80	50	1,5

Vezna ploščica

- obdelava: belo cinkano

Vezna ploščica širine 50 mm

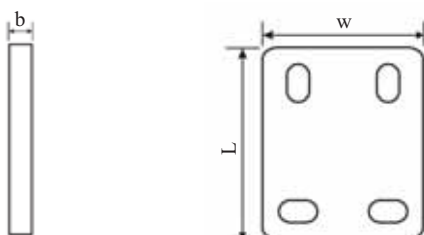

Šifra	Naziv	L mm	w mm	b mm
079144	Ploščica vezna 60x50/2,5 mm 4L Zn nast.	60	50	2,5

Vezna ploščica - nastavljiva

- debelina: 2,5 mm
- obdelava: belo cinkano

STARMAN

Vezna ploščica širine 55 mm

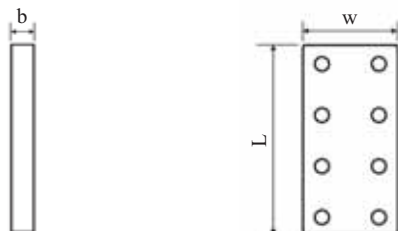

Šifra	Naziv	L mm	w mm	b mm
079257	Ploščica vezna 115x55/2,5 mm 8L Zn	115	55	2,5
079258	Ploščica vezna 135x55/2,5 mm 8L Zn	135	55	2,5

Vezna ploščica

- obdelava: belo cinkano

Trikotnik za omaro

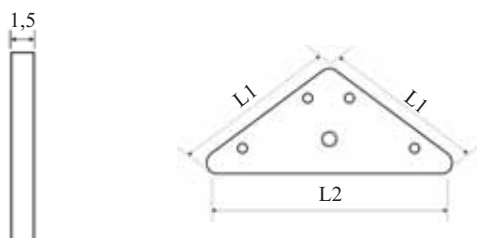

Šifra	Naziv	L1 mm	L2 mm
150394	Trikotnik nosilec za omaro 75x100/1,5 mm Zn	75	100

Trikotnik za omaro

- debelina: 1,5 mm
- obdelava: belo cinkano

Trikotnik za omaro

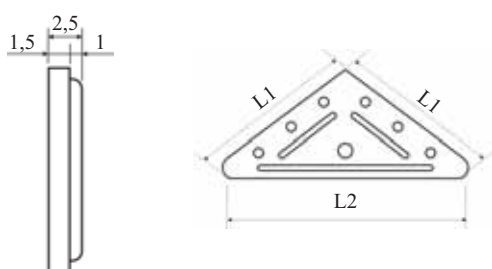

Šifra	Naziv	L1 mm	L2 mm
150379	Trikotnik nosilec za omaro 110x140/1,5 mm Zn	110	140

Trikotnik za omaro

- ojačan
- debelina: 1,5 mm
- celotna debelina: 2,5 mm
- obdelava: belo cinkano



Selotejpi



Šifra	Naziv	Širina mm	Dolžina m	Barva
125623	Selotejpi prozorni 24/66 Aero 1501	24	66	Prozorna
125620	Selotejpi prozorni 48/66 Aero 1501	48	66	Prozorna
125621	Selotejpi rjavi 48/66 Aero 1501	48	66	Rjava

Selotejpi

- za ročno in strojno pakiranje
- za grobe in gladke površine ter za kartone iz recikliranih materialov
- uporaben tudi pri nizkih in povišanih temperaturah
- nosilec: folija
- lepilo: naravni kavčuk
- notranji premer: \varnothing 76 mm

Zaščitni trak



Šifra	Naziv	Širina mm	Dolžina m
125626	Aerokrep 15/50 samolepilni trak Mask 4202 MP	15	50
125608	Aerokrep 19/50 samolepilni trak Mask 4202 MP	19	50
125655	Aerokrep 25/50 samolepilni trak Mask 4202 OB	25	50
125730	Aerokrep 38/50 samolepilni trak Mask 4202 OB	38	50
125731	Aerokrep 50/50 samolepilni trak Mask 4202 OB	50	50

Zaščitni trak

- za kratkotrajno zaščito površin pri avtoličenju, pleskanju, barvanju
- ne pušča ostankov lepila
- namenjen za notranjo uporabo
- obstojen 30 minut pri +80 °C
- nosilec: srednje krepast papir
- lepilo: solventno kavčukovo lepilo srednje lepljivosti
- notranji premer: \varnothing 76 mm
- barva: rumena
- **Opozorilo:** odstraniti takoj po končanem delu oziroma najkasneje v enem dnevu

Lepilni trak



Šifra	Naziv	Širina mm	Dolžina m	Barva
125636	Aero Pack 25/50 rjav-papir 1101	25	50	Rjava
125633	Aero Pack 50/50 rjav-papir 1101	50	50	Rjava

Lepilni trak

- priporoča se za lepljenje embalaže, ki se po uporabi reciklira
- nosilec: rahlo krepast papir
- lepilo: naravni kavčuk
- notranji premer: \varnothing 76 mm



Selotejpi



Šifra	Naziv	Širina mm	Dolžina m	Barva
125648	Selotejpi rjavi 48/66 Tesa	48	66	Rjava
125647	Selotejpi prozorni 48/66 Tesa	48	66	Prozorna

Selotejpi

- nosilec: PP
- zlepljivost (N/25 mm): 7,5
- natezna trdnost (N/25 mm): 100
- debelina: 52 µm
- notranji premer: ø 76 mm
- za zapiranje kartonskih embalaž
- temperaturno in trajnostno odporen

Selotejpi



Šifra	Naziv	Širina mm	Dolžina m	Barva
125659	Selotejpi prozorni PVC 50/66 Tesa	50	66	Prozorna

Selotejpi

- nosilec: PVC
- zlepljivost (N/25 mm): 8
- natezna trdnost (N/25 mm): 150
- debelina: 65 µm
- notranji premer: ø 76 mm
- lahko se potiska
- barva: prozorna

Aluminijasti lepilni trak



Šifra	Naziv	Širina mm	Dolžina m
143089	Aluminium tape 50/50 30 µm Tesa	50	50

Aluminijasti lepilni trak

- nosilec: alu folija
- lepilo: acryl
- debelina folije: 30 µm
- celotna debelina: 60 µm
- visoka odpornost na vlago
- visoka električna prevodnost
- dobra zlepljivost
- zlepljivost na jeklo: 5,6 N/cm
- natezna trdnost: 26 N/cm
- temperaturno območje uporabe: -40 °C do +160 °C
- obdelava traku: sijaj odbojna



Obojestranski lepilni trak



Šifra	Naziv	Širina mm	Dolžina m
143088	Lepilni trak obojestranski tanek 19/50 Tesa	19	50

Obojestranski lepilni trak

- visoka temperaturna obstojnost (kratkotrajno: + 200 °C, dolgotrajno: +100 °C)
- nosilec: PET folija rdeče barve
- lepilo: acryl
- zlepljivost (N/25 mm): 25
- natezna trdnost (N/25 mm): 50
- debelina: 205 µm
- notranji premer: ø 76 mm
- barva: prozorna

Obojestranski lepilni trak



Šifra	Naziv	Širina mm	Dolžina m
143087	Lepilni trak obojestranski 19/50 Tesa	19	50

Obojestranski lepilni trak

- debel obojestranski lepilni trak za pritrditev težjih elementov
- posebej primeren za pritrjevanje ogledal
- visoka odpornost na vlago
- nosilec: PE pena
- zlepljivost (N/25 mm): 14
- natezna trdnost (N/25 mm): 25
- debelina: 1,15 mm
- notranji premer: ø 76 mm
- barva: bela

Izolirni trak



Šifra	Naziv	Širina mm	Dolžina mm
125649	Trak izolirni črn 15/10 Tesa	15	10

Izolirni trak

- za izolacijo električnih kablov
- notranji premer: ø 32 mm
- barva: črna

STARMAN**Lepilni pokrivni trak**

Šifra	Naziv	Širina mm	Dolžina m
143082	Lepilni trak-pokrivni 15/50 za furnir	15	50

Lepilni pokrivni trak

- profesionalni
- temperaturno območje uporabe: do +130 °C

STARMAN

Lepilec za selotejp



Šifra	Naziv
-------	-------

125628	Lepilec za selotejp H11-CP
--------	----------------------------

Lepilec za selotejp

- za selotejpe širine 50 mm
- notranji premer selotejpa: \varnothing 76 mm
- max. zunanji premer selotejpa: \varnothing 115 mm

Stretch folija



Šifra	Naziv	Širina mm
-------	-------	-----------

125632	Folija stretch 100 mm mini rola	100
--------	---------------------------------	-----

125639	Folija stretch 125 mm	125
--------	-----------------------	-----

125637	Folija stretch 250 mm	250
--------	-----------------------	-----

125630	Folija stretch 500 mm 3 kg	500
--------	----------------------------	-----

125638	Folija stretch 500 mm 5 kg	500
--------	----------------------------	-----

Stretch folija

- raztegljiva
- za pakiranje različnih izdelkov

Odvijalec za folijo



Šifra	Naziv
-------	-------

125635	Odvijalec za folijo veliki
--------	----------------------------

Odvijalec za folijo

- za odvijanje folije
- nastavljiva dolžina odvijalca za različne širine folij
- kovinski

Odvijalec za folijo



Šifra	Naziv
-------	-------

125634	Odvijalec za folijo mali
--------	--------------------------

Odvijalec za folijo

- za odvijanje folije
- material: PVC

STARMAN**Embalažna folija**

Šifra	Naziv	Širina mm	Dolžina m
201705	Folija Termosilent 53	1000	25

Embalažna folija

- primerna za pakiranje in za zaščito različnih vrst občutljivih izdelkov kot so pohištvo, steklo, keramika, električni aparati, ...
- majhno vpijanje vode, nizka paraprepustnost
- lahka
- dobra temperaturna obstojnost
- odporna proti različnim kemikalijam
- velika elastičnost in trdnost v širokem temperaturnem območju
- brez vonja in brez toksičnega delovanja
- ekološko neoporečna

PVC trak

Šifra	Naziv	Širina mm	Debelina mm	Dolžina m
148338	Trak super za spenjalnik 15,5x0,7/2000 m	15,5	0,7	2000
148340	Trak super za spenjalnik 12x0,7/1900 m	12	0,7	1900

PVC trak

- za spajanje različnih embalaž (embalaža na paletah, kartonske škatle, ...)

Sponka za PVC trak

Šifra	Naziv
148332	Sponke kovinske za trak KOM 16 mm pakirano 1000 kos
148352	Sponke za trak kovinske 13 mm pakirano 2000 kos

Sponka za PVC trak

- kovinska
- obdelava: belo cinkano

Vogalnik

Šifra	Naziv
148339	Vogalnik plastični mali 30 mm 2000 kos

Vogalnik

- za utrditev vogalov pri spajanju s trakom
- material: PVC

STARMAN

Spenjalnik za trak



Šifra	Naziv
-------	-------

148335	Spenjalnik ročni za PVC trak 16 mm
--------	------------------------------------

Spenjalnik za trak

- ročni
- kovinski

Odvijalec za trak



Šifra	Naziv
-------	-------

125643	Odvijalec za trak 13, 16 mm
--------	-----------------------------

Odvijalec za trak

- vzmetni mehanizem preprečuje неконтролірано odvijanje traku
- kovinski
- gumijasta ročaja
- predal za orodje
- na kolesih za lažje prevažanje

STARMAN

Mozniki



Šifra	Naziv	Premer (ø) mm	Dolžina mm	Pakirano kg
150035	Mozniki 6x25 mm	6	25	3
150125	Mozniki 6x26 mm	6	26	3
150114	Mozniki 6x30 mm	6	30	3
150099	Mozniki 6x32 mm	6	32	3
150094	Mozniki 6x35 mm	6	35	3
150115	Mozniki 7,9x35 mm	7,9	35	3
150117	Mozniki 8x25 mm	8	25	3
150119	Mozniki 8x28 mm	8	28	3
150112	Mozniki 8x30 mm	8	30	3
150113	Mozniki 8x32 mm	8	32	3
150110	Mozniki 8x35 mm	8	35	3
150118	Mozniki 8x38 mm	8	38	3
150107	Mozniki 8x40 mm	8	40	3
150095	Mozniki 8x50 mm	8	50	3
150512	Mozniki 8x60 mm	8	60	3
150519	Mozniki 8x80 mm	8	80	3
150126	Mozniki 10x30 mm	10	30	3
150111	Mozniki 10x35 mm	10	35	3
150533	Mozniki 10x38 mm	10	38	3
150514	Mozniki 10x40 mm	10	40	3
150517	Mozniki 10x45 mm	10	45	3
150108	Mozniki 10x50 mm	10	50	3
150515	Mozniki 10x60 mm	10	60	3
150087	Mozniki 10x70 mm	10	70	3
150516	Mozniki 10x80 mm	10	80	3
150518	Mozniki 10x100 mm	10	100	3
150534	Mozniki 12x32 mm	12	32	3
150535	Mozniki 12x40 mm	12	40	3
150105	Mozniki 12x50 mm	12	50	3
150104	Mozniki 12x60 mm	12	60	3
150086	Mozniki 12x70 mm	12	70	3
150116	Mozniki 12x75 mm	12	75	3
150085	Mozniki 12x80 mm	12	80	3
150097	Mozniki 12x90 mm	12	90	3
150096	Mozniki 12x100 mm	12	100	3
150098	Mozniki 12x120 mm	12	120	3
150291	Mozniki 14x50 mm	14	50	3
150513	Mozniki 16x60 mm	16	60	3
150527	Mozniki 16x70 mm	16	70	3
150532	Mozniki 16x100 mm	16	100	3

Mozniki

- na voljo tudi pakiranje 20 kg

STARMAN

Mozniki-palica - rebrasti



Šifra	Naziv	Premer (ø) mm	Dolžina mm
150520	Mozniki-palica fi 6x1000 mm	6	1000
150521	Mozniki-palica fi 8x1000 mm	8	1000
150522	Mozniki-palica fi 10x1000 mm	10	1000
150523	Mozniki-palica fi 12x1000 mm	12	1000
150109	Mozniki-palica fi 14x1000 mm	14	1000
150524	Mozniki-palica fi 16x1000 mm	16	1000

Moznik-palica

- rebrasti

Mozniki-palica - gladki



Šifra	Naziv	Premer (ø) mm	Dolžina mm
150528	Mozniki-palica fi 6x1000 mm gladka	6	1000
150529	Mozniki-palica fi 8x1000 mm gladka	8	1000
150034	Mozniki-palica fi 10x1000 mm gladka	10	1000
150526	Mozniki-palica fi 12x1000 mm gladka	12	1000
150033	Mozniki-palica fi 14x1000 mm gladka	14	1000
150032	Mozniki-palica fi 16x1000 mm gladka	16	1000
150525	Mozniki-palica fi 18x1000 mm gladka	18	1000

Moznik-palica

- gladki

Lamelica za spajanje



Šifra	Naziv	Dolžina mm	Širina mm	Debelina mm
150712	Lamelca 0 Starman	43	15	4
150711	Lamelca 10 Starman	54	20	4
150710	Lamelca 20 Starman	57	25	4

Lamelica za spajanje

- pakirano: 1000 kos

Smolike



Šifra	Naziv	Dolžina mm	Širina mm	Višina mm
150500	Smolna krpa - smolika javor	70	8	14
150501	Smolna krpa - smolika smreka	70	8	14
150502	Smolna krpa - smolika macesen	70	8	14
150503	Smolna krpa - smolika hrast	70	8	14
150504	Smolna krpa - smolika bor	70	8	14
150505	Smolna krpa - smolika bukev	70	8	14

Smolika

- za nadomestilo smol v lesu

- pakirano: 500 kos

STARMAN**Grče**

Šifra	Naziv	Premer (Ø) mm	Debelina mm	Pakirano kos
150506	Grče fi 15 mm pakirano 500 kos	15	9	500
150507	Grče fi 20 mm pakirano 500 kos	20	9	500
150508	Grče fi 25 mm pakirano 300 kos	25	9	300
150509	Grče fi 30 mm pakirano 200 kos	30	9	200
150510	Grče fi 35 mm pakirano 200 kos	35	9	200

Grče

- za nadomestilo izpadnih grč v lesu
- grče so rezane iz vej

STARMAN

Podstavek za kvadratne cevi

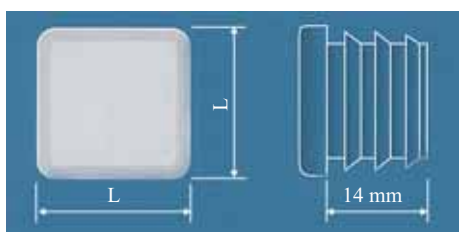

Šifra	Naziv	L mm	Pakirano kos
080600	Podstavek PO - 16x16 mm 1 cent	16	100
080601	Podstavek PO - 20x20 mm 1 cent	20	100
080629	Podstavek PO - 22x22 mm 0,5 cent	22	50
080618	Podstavek PO - 25x25 mm 0,5 cent	25	50
080602	Podstavek PO - 30x30 mm 0,5 cent	30	50
080619	Podstavek PO - 35x35 mm 0,25 cent	35	25
080603	Podstavek PO - 40x40 mm 0,25 cent	40	25
080604	Podstavek PO - 50x50 mm 0,2 cent	50	20
080626	Podstavek PO - 60x60 mm 0,5 cent	60	50

Podstavek za kvadratne cevi

- material: PE
- barva: črna

Podstavek za pravokotne cevi

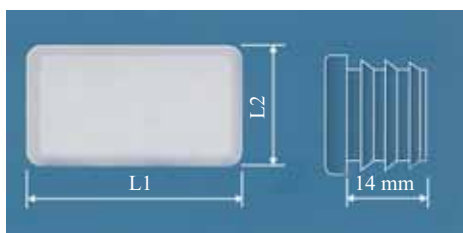

Šifra	Naziv	L1 mm	L2 mm	Pakirano kos
080614	Podstavek PO - 30x15 mm 1 cent	30	15	100
080605	Podstavek PO - 30x20 mm 1 cent	30	20	100
080606	Podstavek PO - 40x20 mm 1 cent	40	20	100
080615	Podstavek PO - 40x30 mm 0,5 cent	40	30	50
080607	Podstavek PO - 50x30 mm 0,5 cent	50	30	50
080616	Podstavek PO - 60x40 mm 0,5 cent	60	40	50

Podstavek za pravokotne cevi

- material: PE
- barva: črna

STARMAN

Podstavek za okrogle cevi

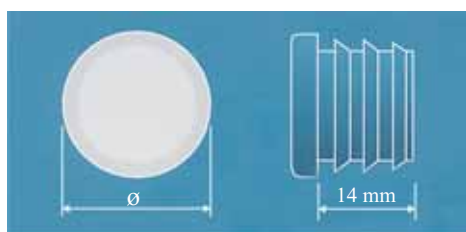

Šifra	Naziv	Premer (Ø) mm	Pakirano kos
080608	Podstavek PO - 1/2 " 1 cent	22	100
080609	Podstavek PO - 3/4 " 1 cent	27	100
080610	Podstavek PO - 1 " 1 cent	34	100
080611	Podstavek PO - 5/4 " 0,25 cent	42	25
080612	Podstavek PO - 6/4 " 0,25 cent	48	25
080613	Podstavek PO - 2 " 0,25 cent	60	25
080627	Podstavek PO - fi 18 mm 3/8 " 1 cent	18	100
080622	Podstavek PO - fi 20 mm 1 cent	20	100
080620	Podstavek PO - fi 22 mm 1 cent	22	100
080625	Podstavek PO - fi 25 mm 0,5 cent	25	50
080623	Podstavek PO - fi 28 mm 1 cent	28	100
080617	Podstavek PO - 40 mm 0,5 cent	40	50
080628	Podstavek PO - 42/38 mm 0,5 cent	42	50
080621	Podstavek PO - fi 60 mm 0,25 cent	60	25

Podstavek za okrogle cevi

- material: PE
- barva: črna

STARMAN

Samolepilne pokrivne kapice po dekorjih Starman - premer kapic ø 14 mm

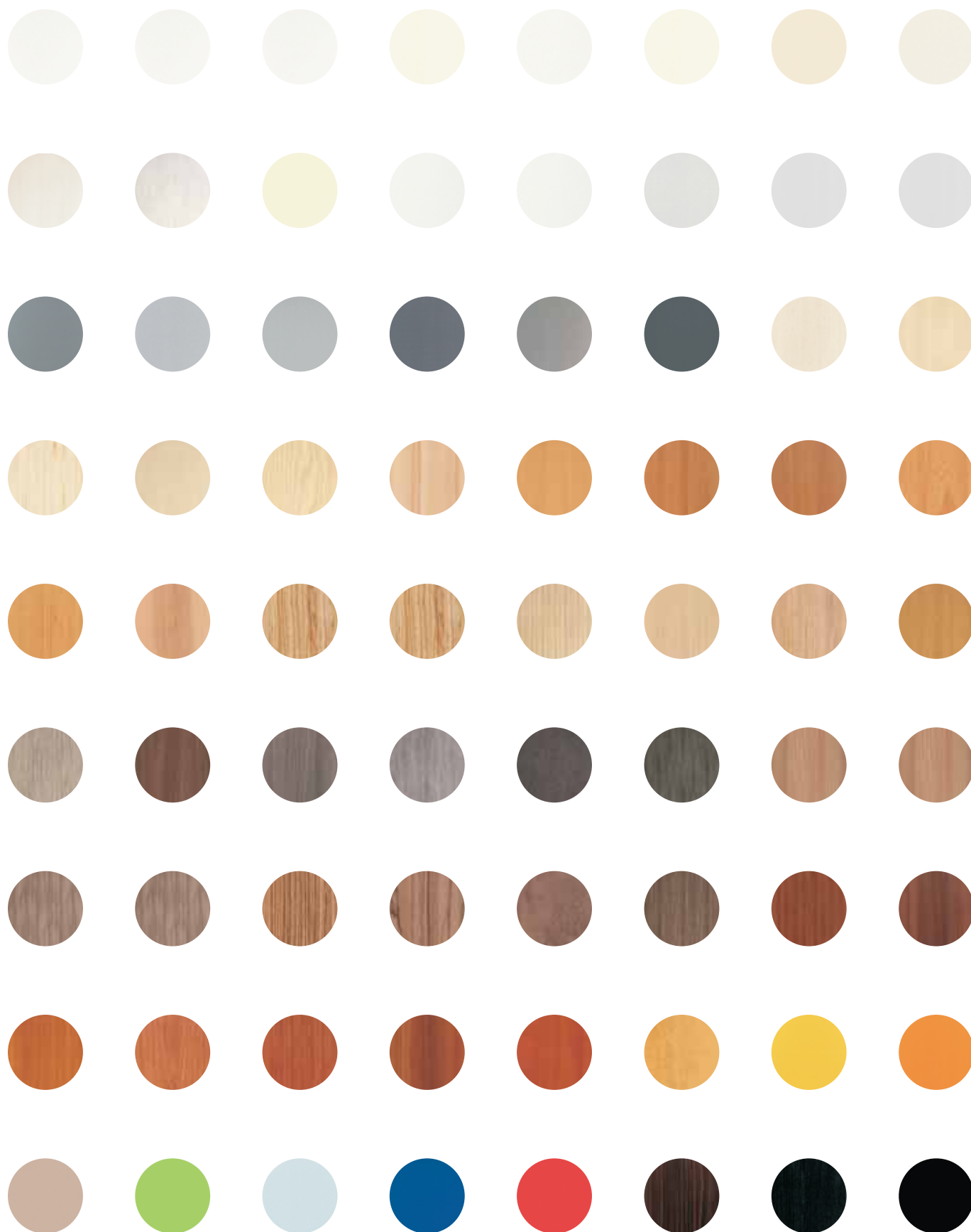



STARMAN

Starman d.o.o., Žeje pri komendi 122, 1218 Komenda, Slovenija

tel.: + 386 (0)1 724 79 00

fax: + 386 (0)1 724 79 19

e-mail: info@starman.si

www.starman.si

v 1.0 februar 2011